

# MOONZOME

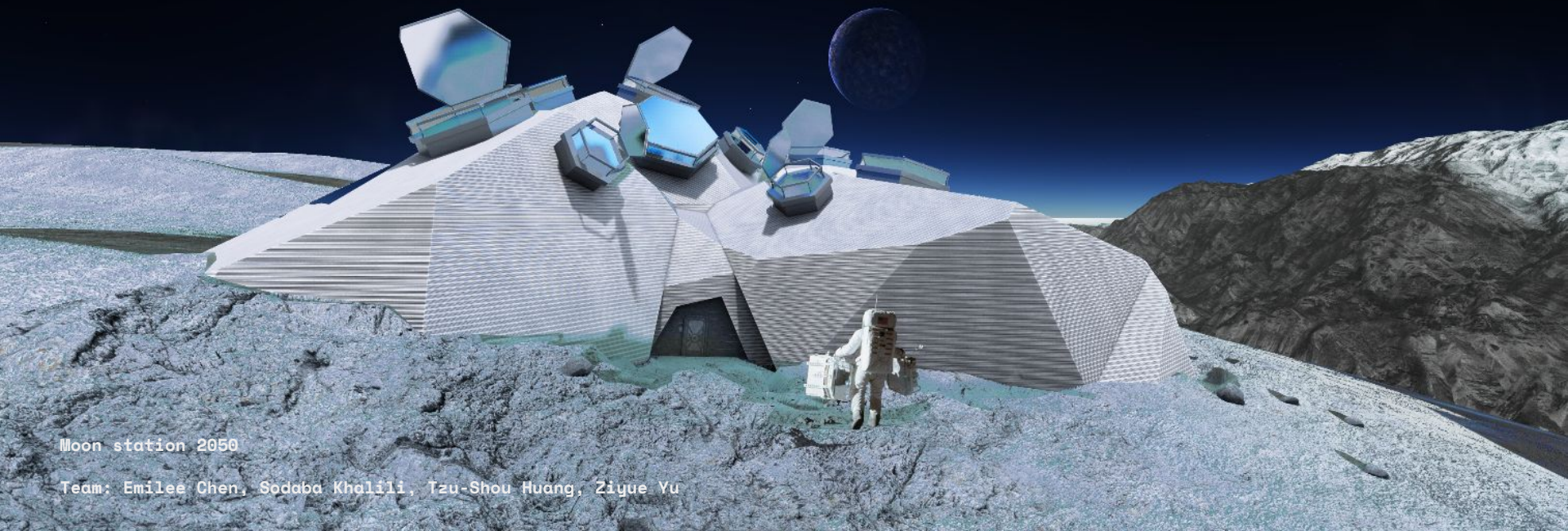

Moon station 2050

Team: Emilee Chen, Sodaba Khalili, Tzu-Shou Huang, Ziyue Yu

# Lunar Architecture\_Considerations

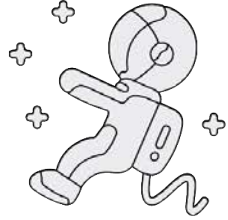

Low gravity (1.6m/s<sup>2</sup>)

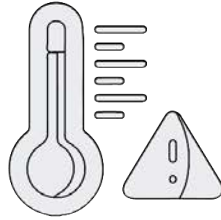

Extreme thermal cycle  
(-173°C to +117°C)



29.53 earth days  
for one lunar day

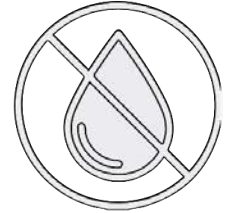

Limited access  
to liquid water

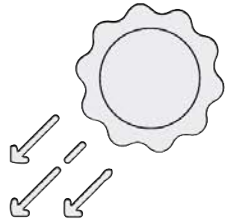

High level of radiation and  
solar particle events

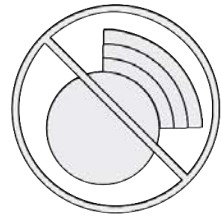

Lack of atmosphere

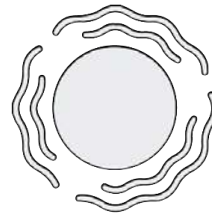

Higher seismic activity  
than for Earth

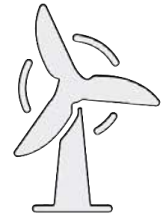

No weather: no wind:  
no wind turbines

# Lunar Architecture\_Materials

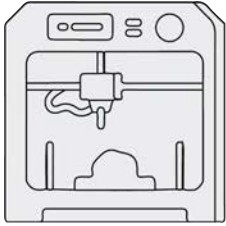

**Lunar soil for 3D-printing**

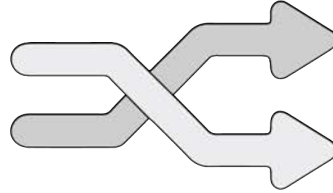

**Interlocking parts  
for 3D-print (flexibility)**

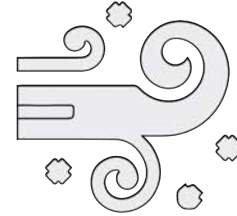

**Airtight at all times**

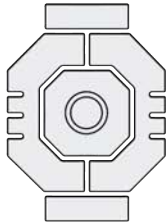

**Airlocks as openings**

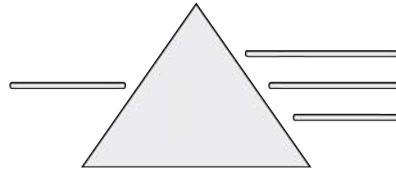

**Smaller/lighter materials**

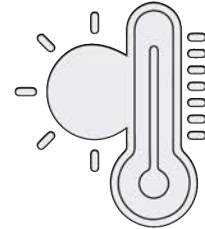

**Protection from the radiation  
and meteoroids**

# Lunar Architecture\_Program Requirements

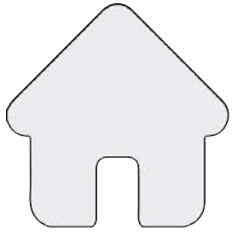

Eating/sleeping areas  
for 3-6 people

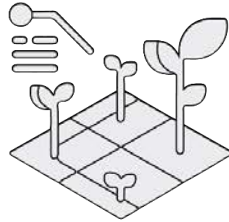

Grow food



Research and experiments

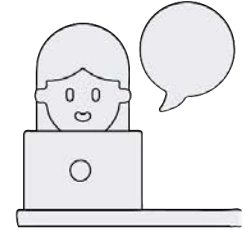

Communication with earth

# Site Analysis

# Site Selection

Site 2:

The Lunar south polar ridge on the left of Shackleton Crater

Station Site:

Along the Earth-facing slope of the Lunar south polar ridge, along the upper edge of an approximately 800m diameter crater there, facing downslope and toward Earth (which should be occasionally low on the south polar horizon).

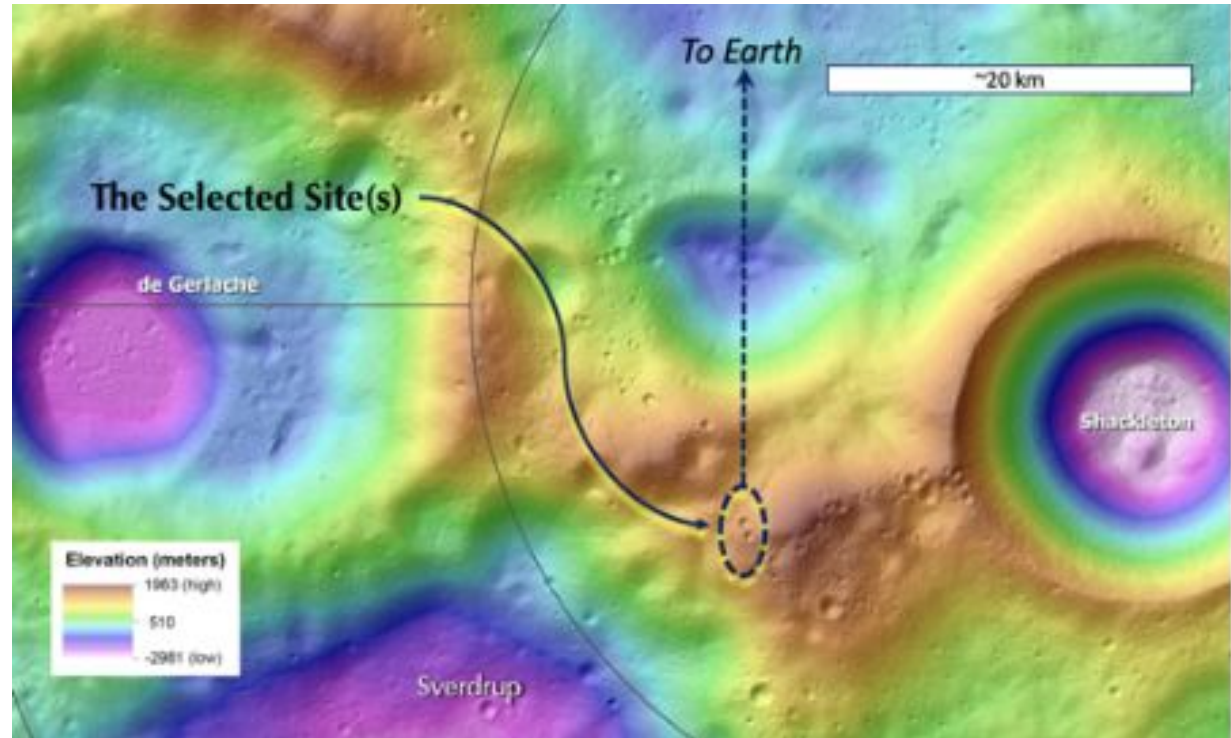

# Site Selection\_Considerations + Opportunities

+ The ridge along the crater's rim is exposed to almost **constant sunlight**

+ The interior of the crater is perpetually in shadow that may indicate the **presence of water ice**

+ The variance in sunlight and resource quality allows for spaces of different functions

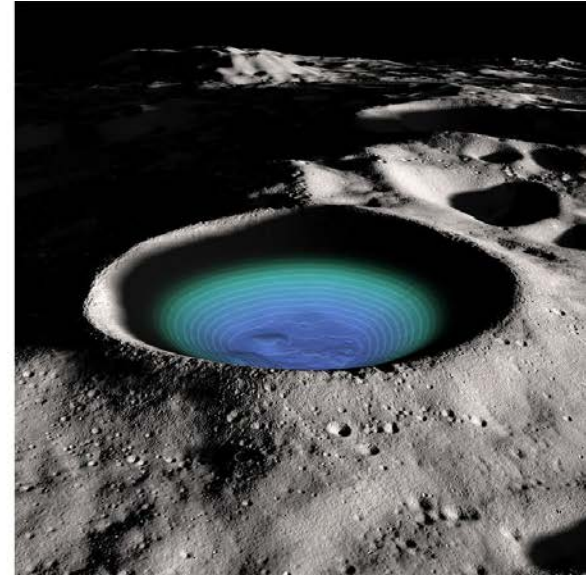
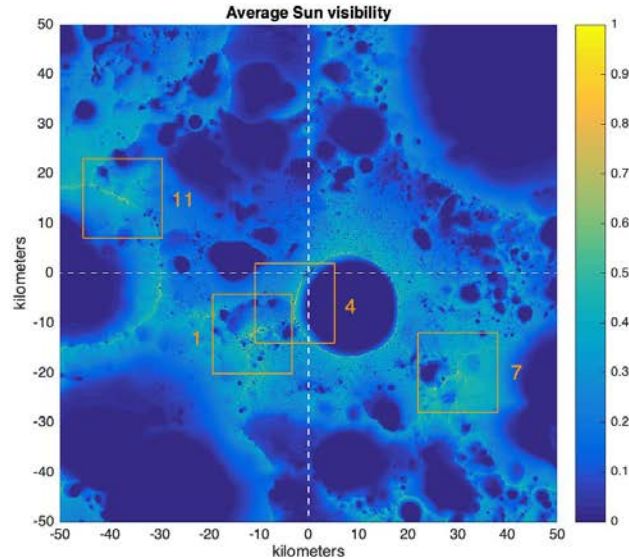

# Site Selection\_Features

- + Features mapped (isolated boulders, rock exposures, rocky craters) overlaid on geomorphological map.
- + Distribution of features in relation to the geomorphic units can be seen, including around the "Connecting Ridge" the moderately slumped unit aligns with the mapped features.

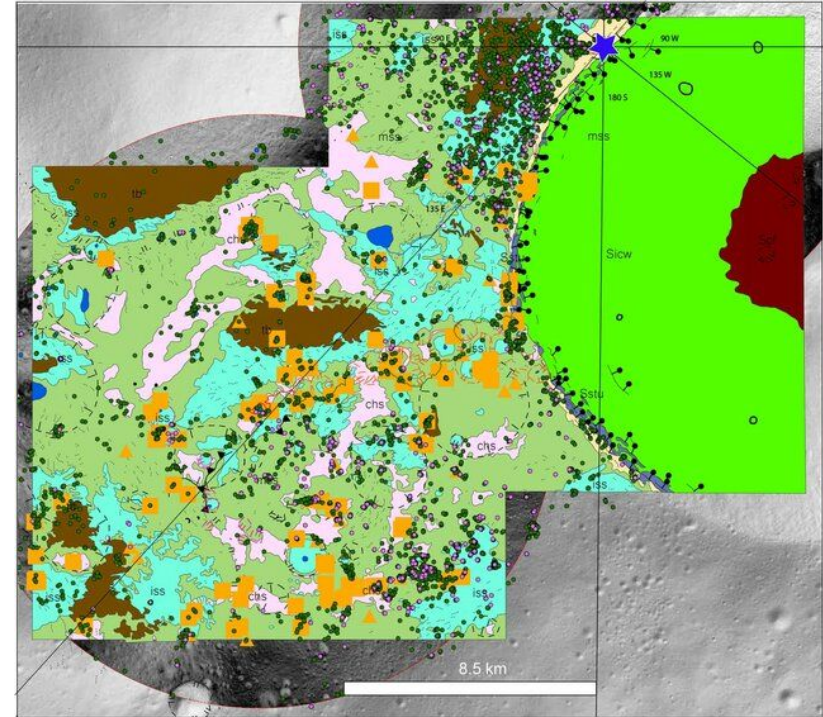
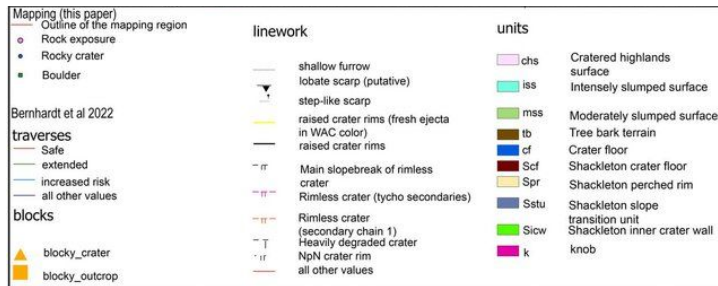



# Site Selection\_Features

- + Depth of ice in the area mapped
- + Provides insight into possible water collection and system to be implemented, as well as water that can be used for in-situ material use
- + Insight on ground composition for **foundations and excavation**

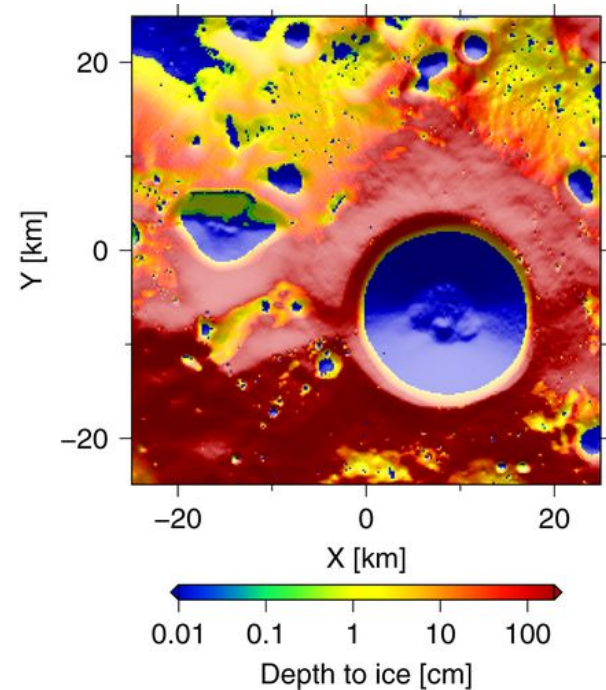

# Site Selection\_Features

- + Assumed ground composition of the site area.
- + Shows depth of excavation possible, and potential material collection for in situ construction
- + Loose regolith can be collected to use for 3D print construction material:  
**cementless concrete or geopolymers**

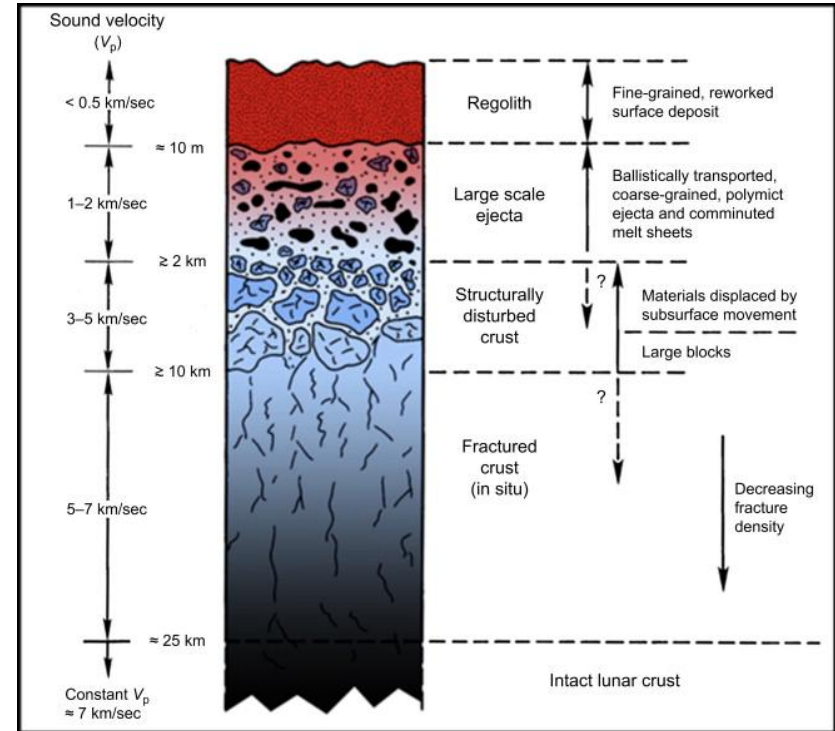

# Site Selection\_Slope

- + By looking at mapping of the slopes around the lunar south pole and the selected site, the topography can be leveraged in the design.
- + Selected site area has topography between **15° - 20°**

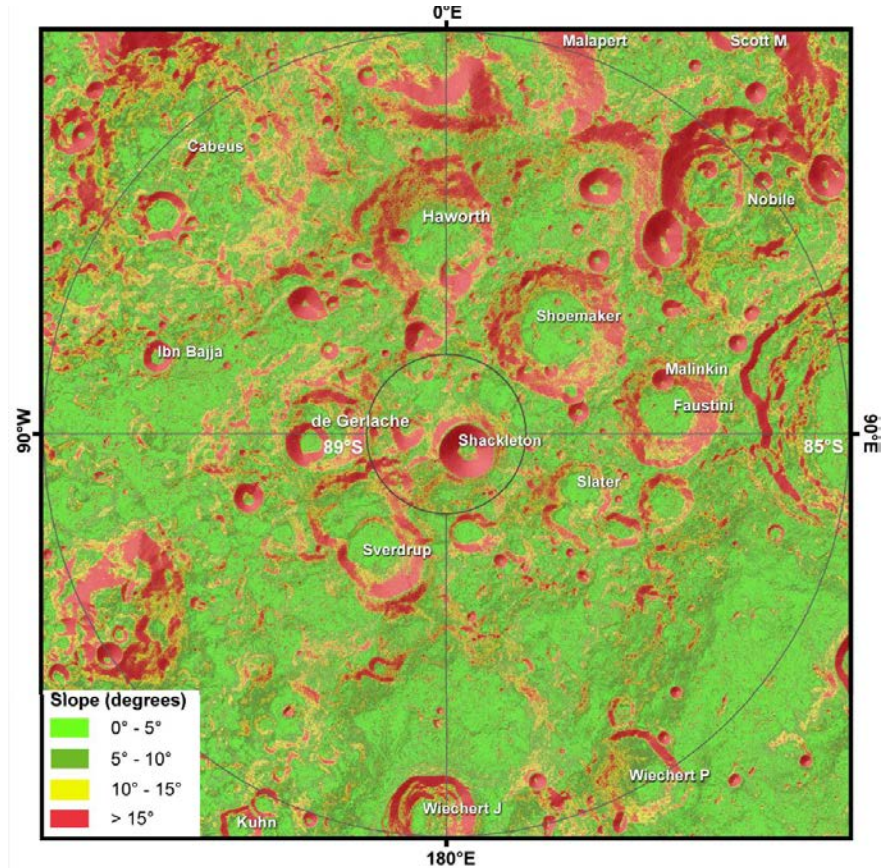

# Site selection



Site Chosen: Area 2: The lunar south polar ridge on the left of Shackleton Crater Station  
Center Coordinates: 89.45°, 222.69°E

References / Case Studies

# Lunar Architecture\_Space Precedents

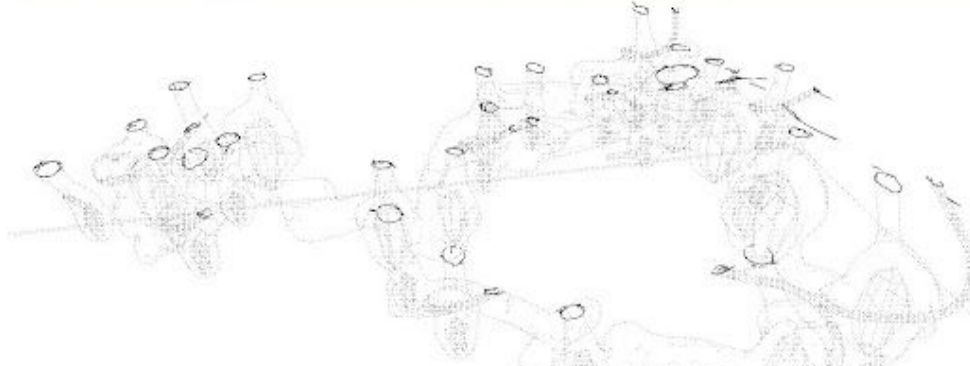
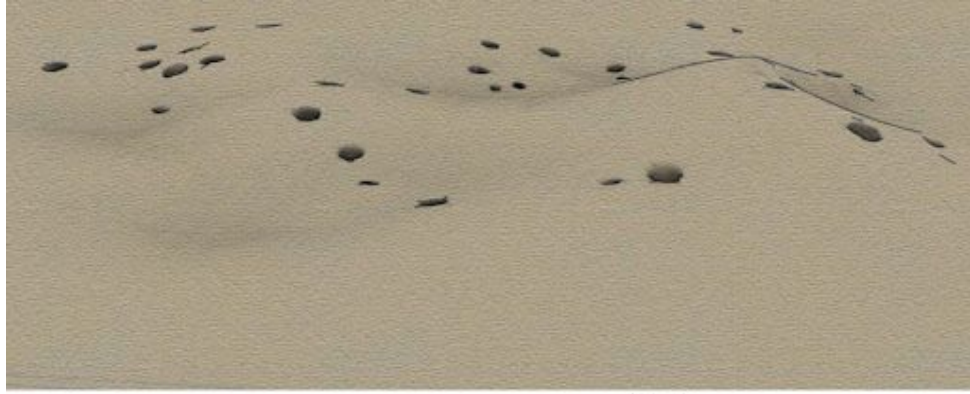

Rhizome 1.0- underground constructions using local regolith for radiation and temperature protection

# Lunar Architecture\_Space Precedents



central atrium for light distribution

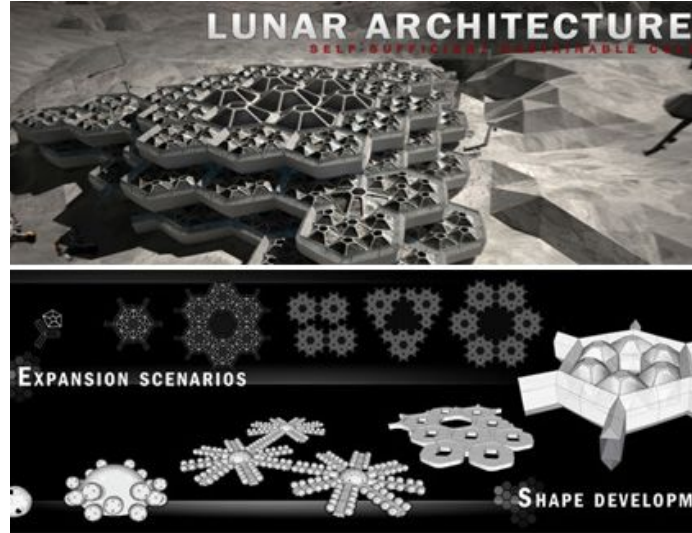

node system for possible expansion

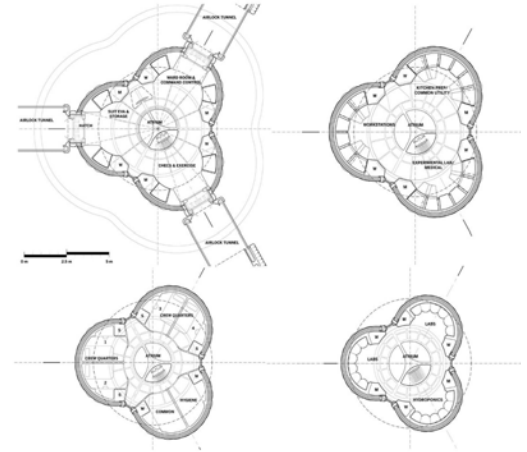

Figure 11. Vertical habitat plans.

stacked structures

# Lunar Architecture\_Concept Design



University of Urbino, Italy. Residences.

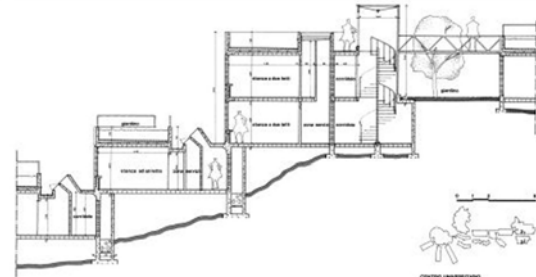
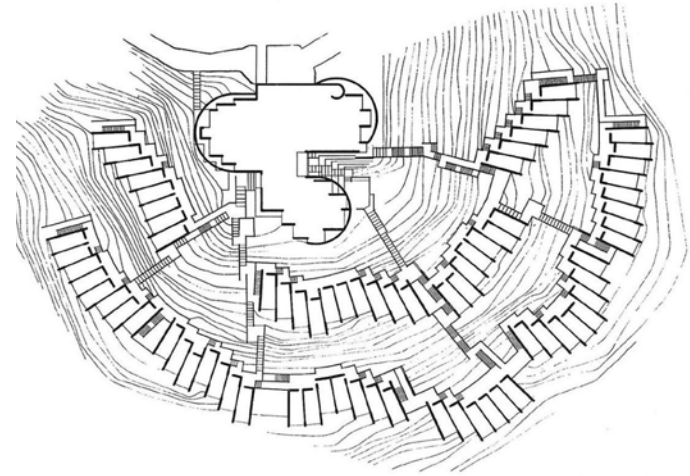



# Lunar Architecture\_On Earth Precedents

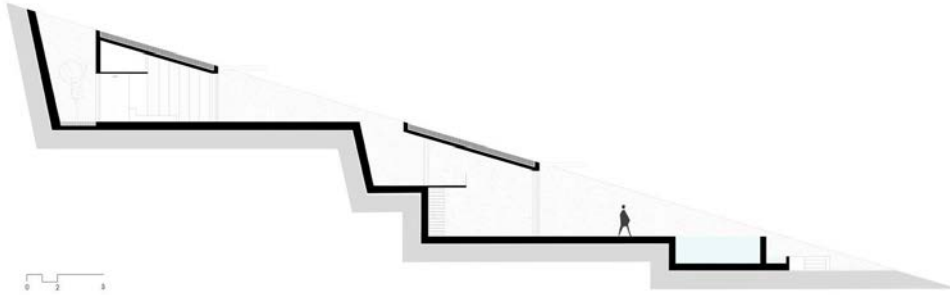

NCave House. Agios Sostis, Greece

# Conceptual Design

# Voronoi Logic

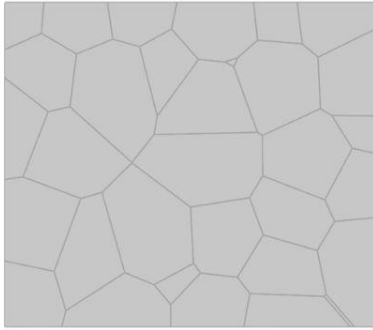

Voronoi Cell Construction

+

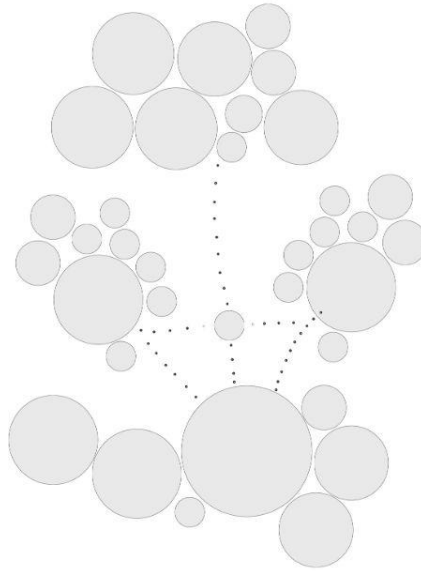

Programme Organization

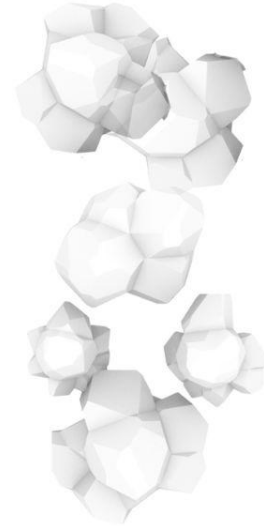

Voronoi cell organization



# Concept Design\_Spatial Layout

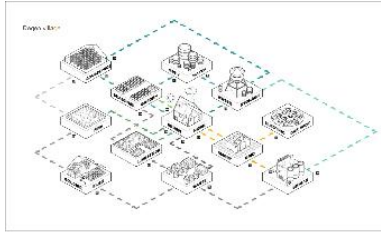

Table 2: Evaluation of possible living module configurations.

Living Module Configuration	Characteristics	Advantages
	<ul style="list-style-type: none"> <li>Provides a central atrium.</li> <li>Allows for easy access to all modules.</li> <li>Allows for easy access to the airlock.</li> </ul>	<ul style="list-style-type: none"> <li>Easy access to all modules.</li> <li>Easy access to the airlock.</li> </ul>
	<ul style="list-style-type: none"> <li>Provides a central atrium.</li> <li>Allows for easy access to all modules.</li> <li>Allows for easy access to the airlock.</li> </ul>	<ul style="list-style-type: none"> <li>Easy access to all modules.</li> <li>Easy access to the airlock.</li> </ul>
	<ul style="list-style-type: none"> <li>Provides a central atrium.</li> <li>Allows for easy access to all modules.</li> <li>Allows for easy access to the airlock.</li> </ul>	<ul style="list-style-type: none"> <li>Easy access to all modules.</li> <li>Easy access to the airlock.</li> </ul>
	<ul style="list-style-type: none"> <li>Provides a central atrium.</li> <li>Allows for easy access to all modules.</li> <li>Allows for easy access to the airlock.</li> </ul>	<ul style="list-style-type: none"> <li>Easy access to all modules.</li> <li>Easy access to the airlock.</li> </ul>



Reference  
Designing following function

**Food**  
Aquaponics  
Produce Vegetables and Fruit for the Living Modules

**Algae**  
Purifies water and become edible nutrients.

**Living Quarters**

**Circulation**  
**Kitchen**  
utilises food from the Greenhouse and the purified water

**Energy**

**Solar Cells and Smart Grid**  
provides energy for the homes and distribute the surplus of energy to the smart grid

**Biogas Facility**  
Energy produce in the biogas is added in the smart grid

**Charging Station**  
Smart grid will be used for the robots charging station

**Laser Power Beaming for Lunar Polar Exploration**  
Base station on the, beaming power to multiple rovers exploring the permanently shadowed craters of the moon

**Construction Process**  
**Inflatable Membrane**  
Deployment of airlock module. After the inflation is completed

**Regolith Foundation**  
Multiple printers follow the circumference of the building, depositing raw regolith and binding it layer by layer.

**Regolith Foundation**  
The robots will cover the whole membrane with regolith in voronoi form.

**Lunar Base Configuration**

**Star**  
**Fire and Airlock Failure**  
Complex build up  
No restricted access in case of airlock failure  
Low risk associated with airlock failure is absent

Floorplan  
Modulated System Membrane

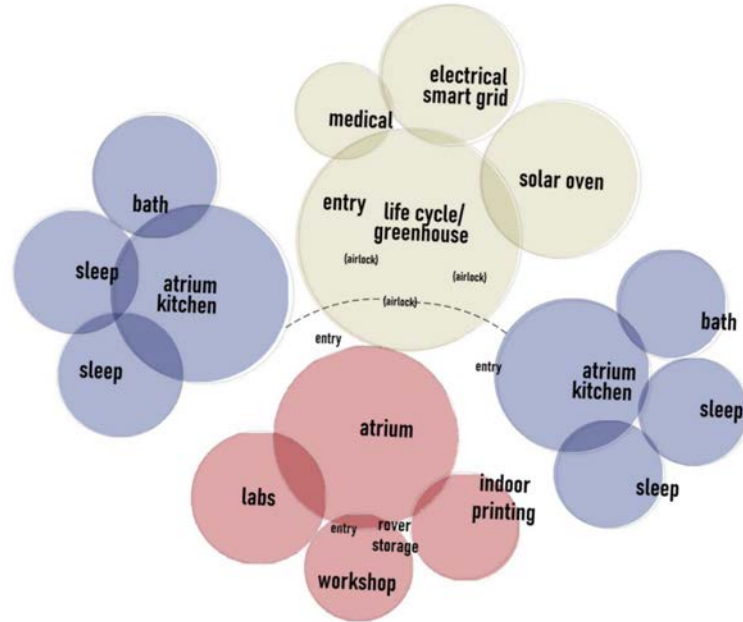

# Concept Design\_Use of Topography

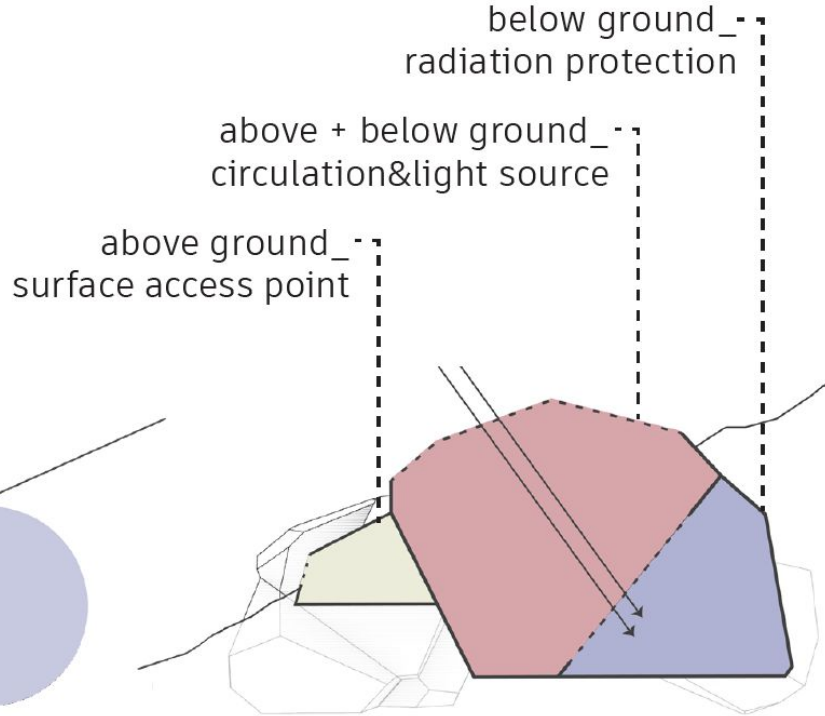
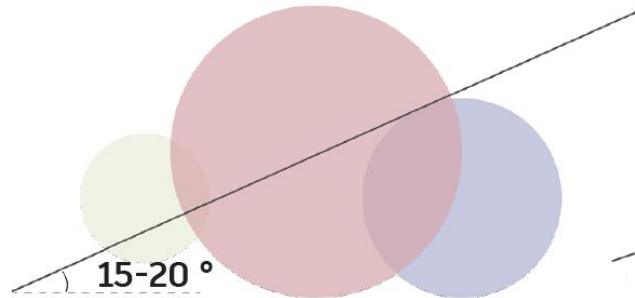
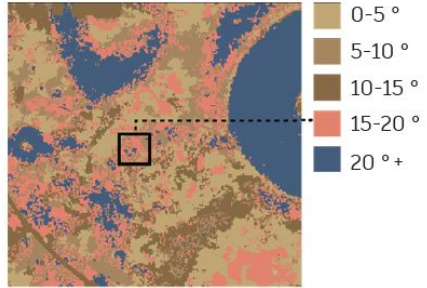

# Concept Design\_Form Finding

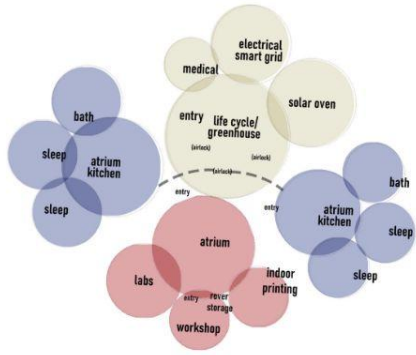

Floorplan

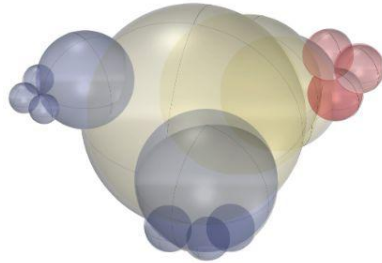

Zoning of space

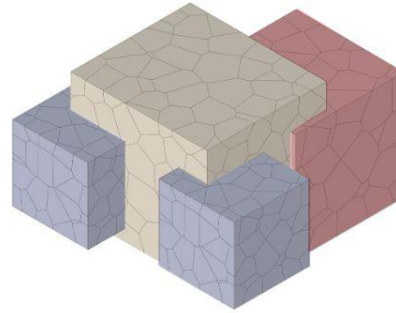

Bounding box

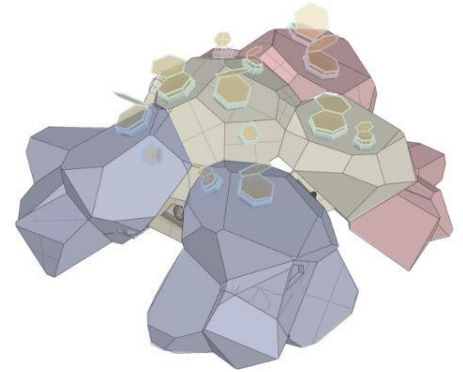

Voronoi generation





# Floorplan

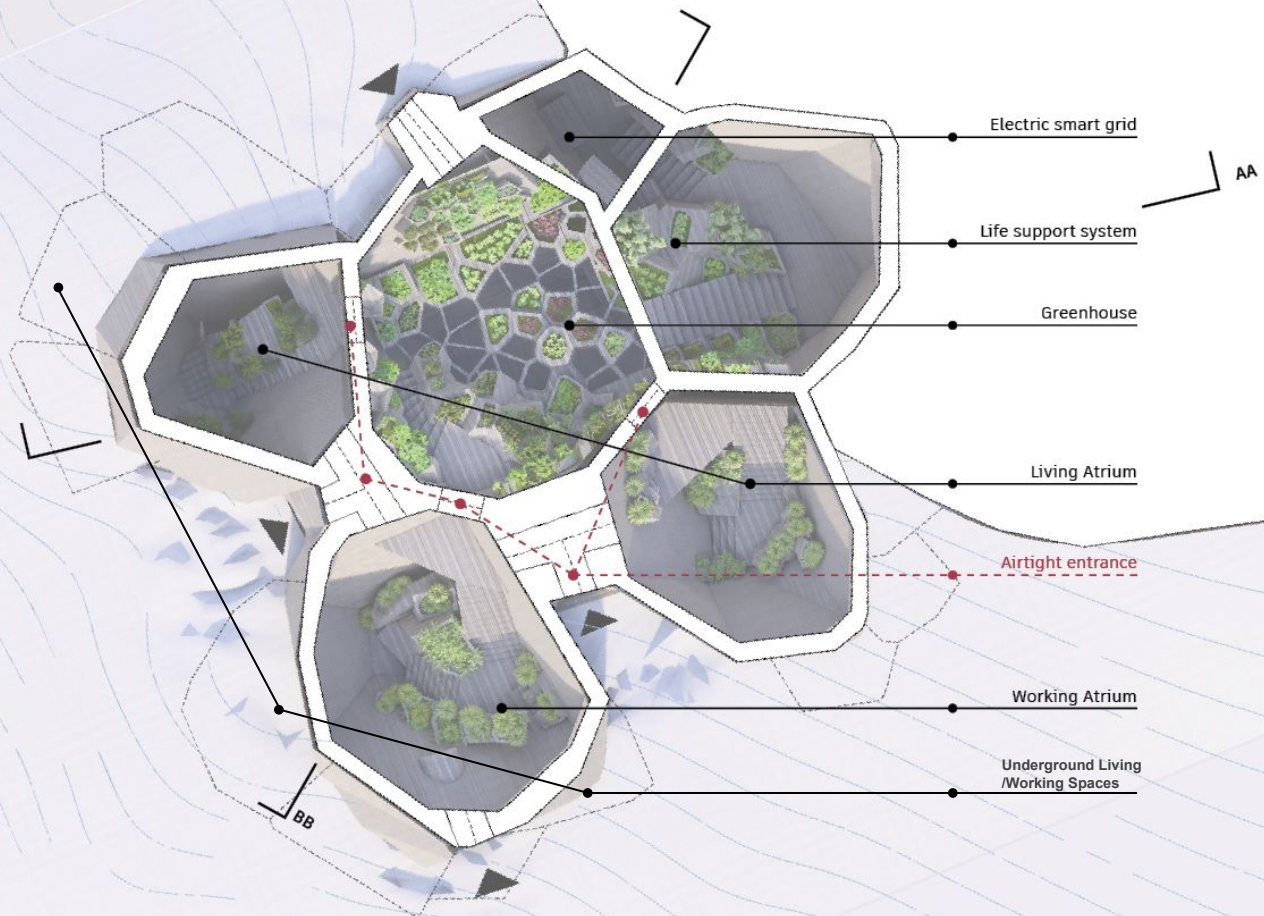

# Section

LIFE SUPPORT CLUSTER

LIVING CLUSTER

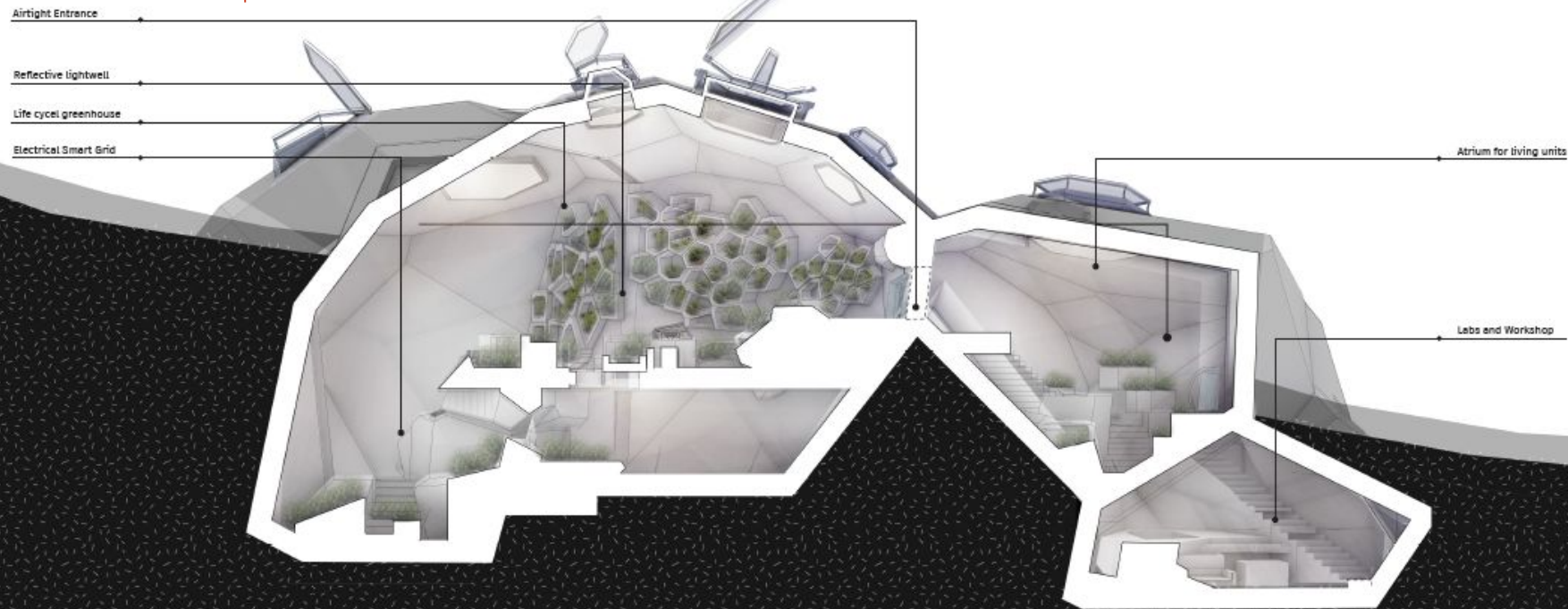

Life Support + Agriculture

Interior Mapping\_ points to voronoi

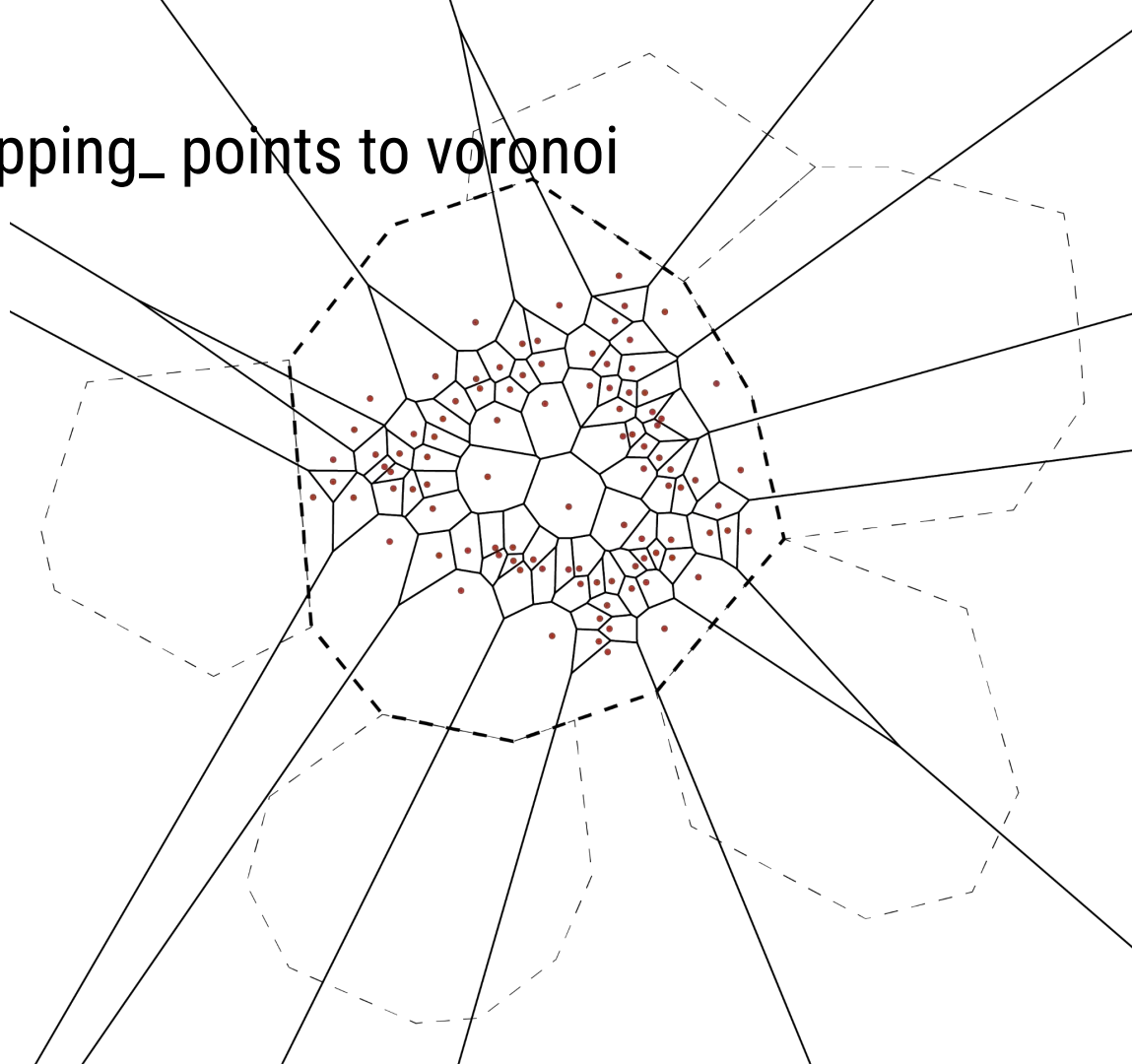

# Interior Mapping\_ points to voronoi

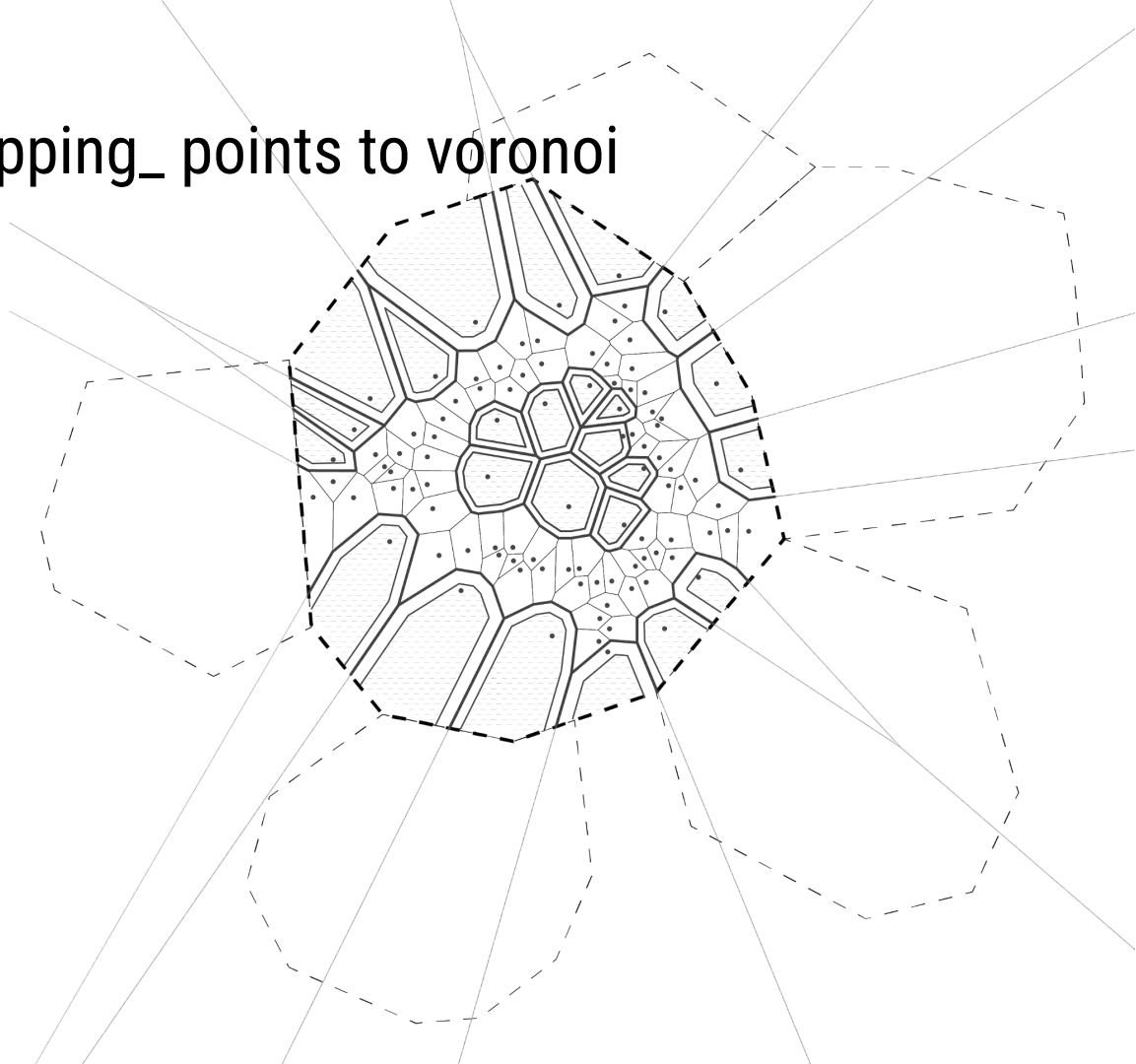

# Interior Mapping\_ Circulation from point density

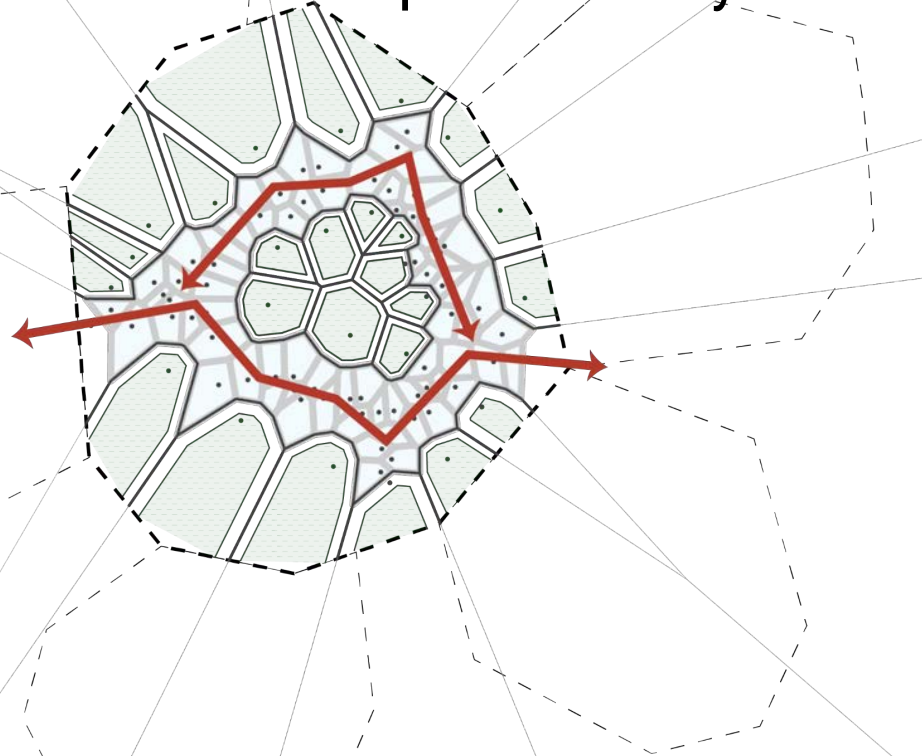

## Potential Transparent Materials Manufactured in situ:

**Sintered regolith:** heating and pressing lunar soil

**Quenched molten basalt:** rapidly cooling molten basalts.

# Axonometric Section



# Wall Planters

Interior walls can follow voronoi building block logic at a larger scale, creating a not smooth, but textured wall. Depth difference between voronoi components at this scale can be used for furniture and planters.

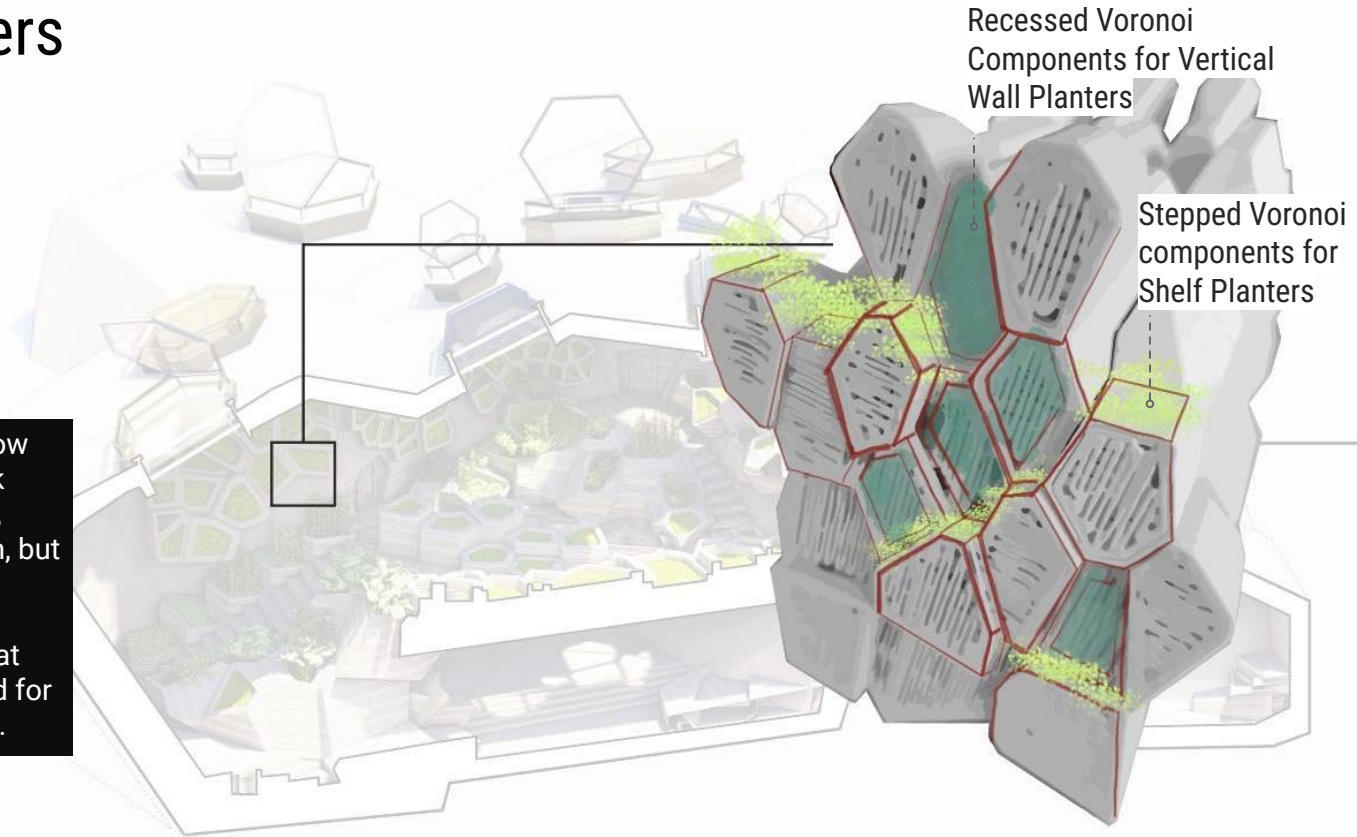



# Interior: Greenhouse



# Life Support\_Water

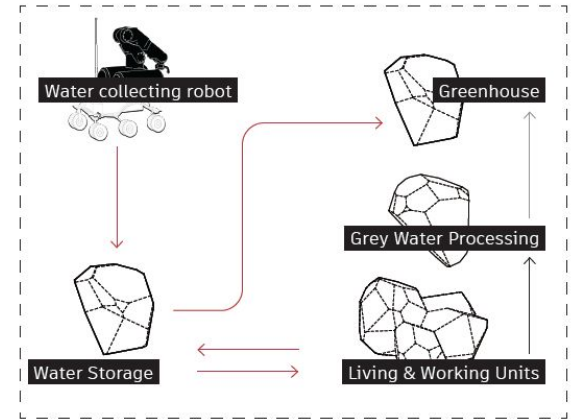
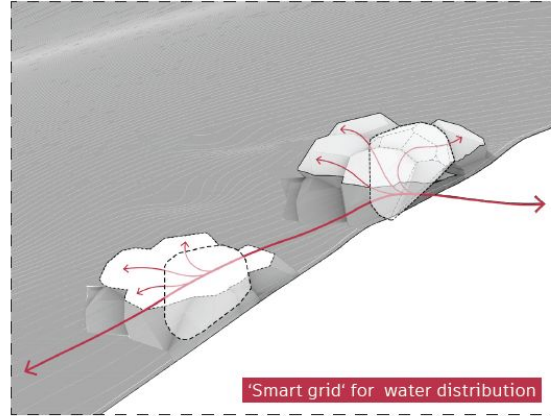
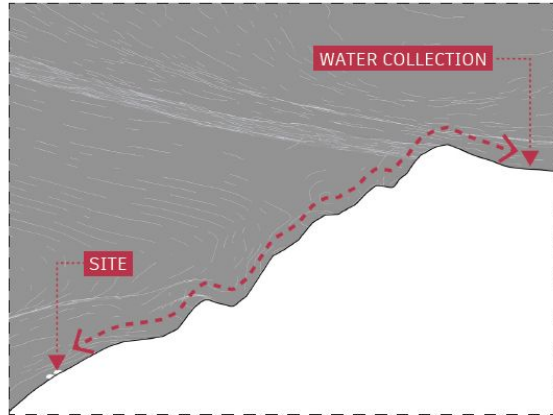

# Life Support\_Energy

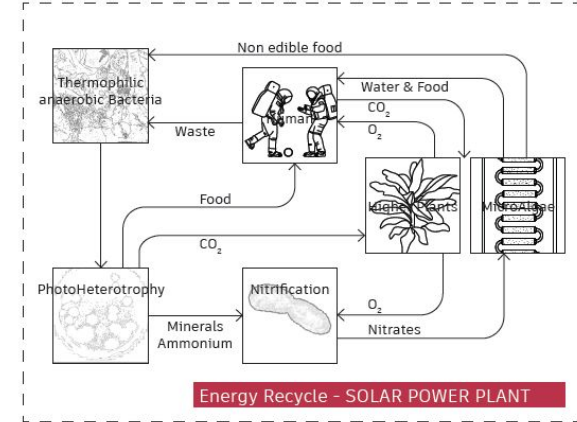
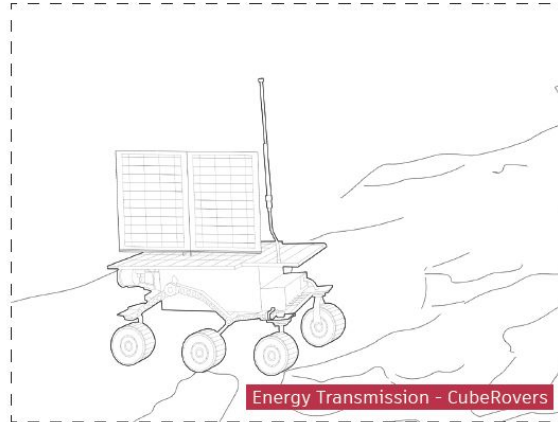
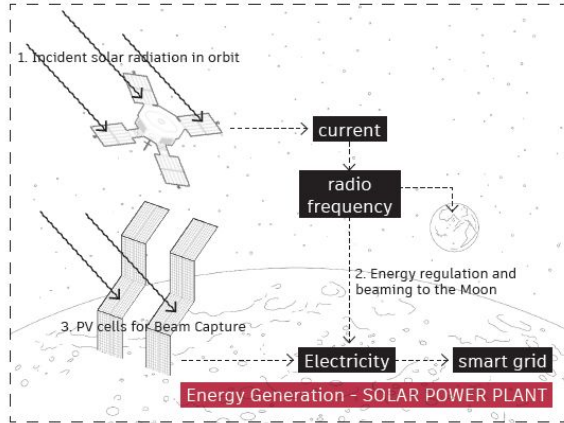



Living Fragment

# Fragment\_ Entrance-Living-Atrium

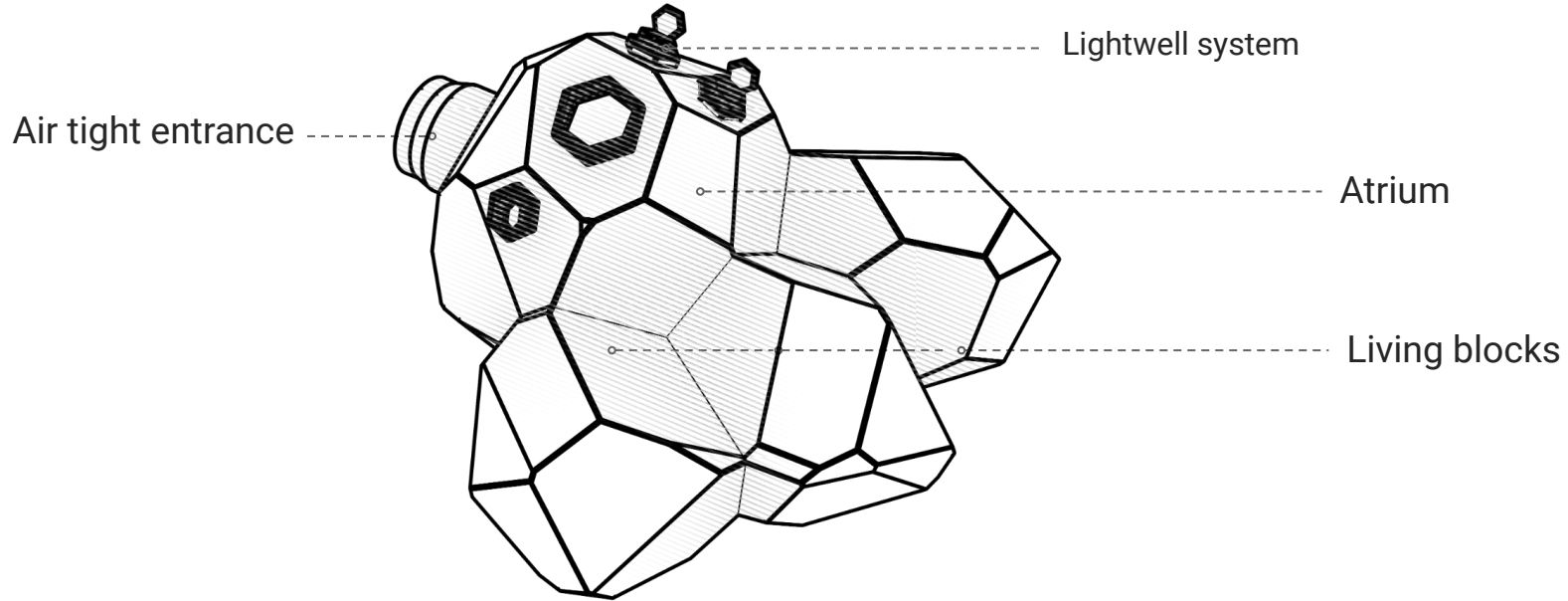

# Fragment\_ Entrance-Living-Atrium

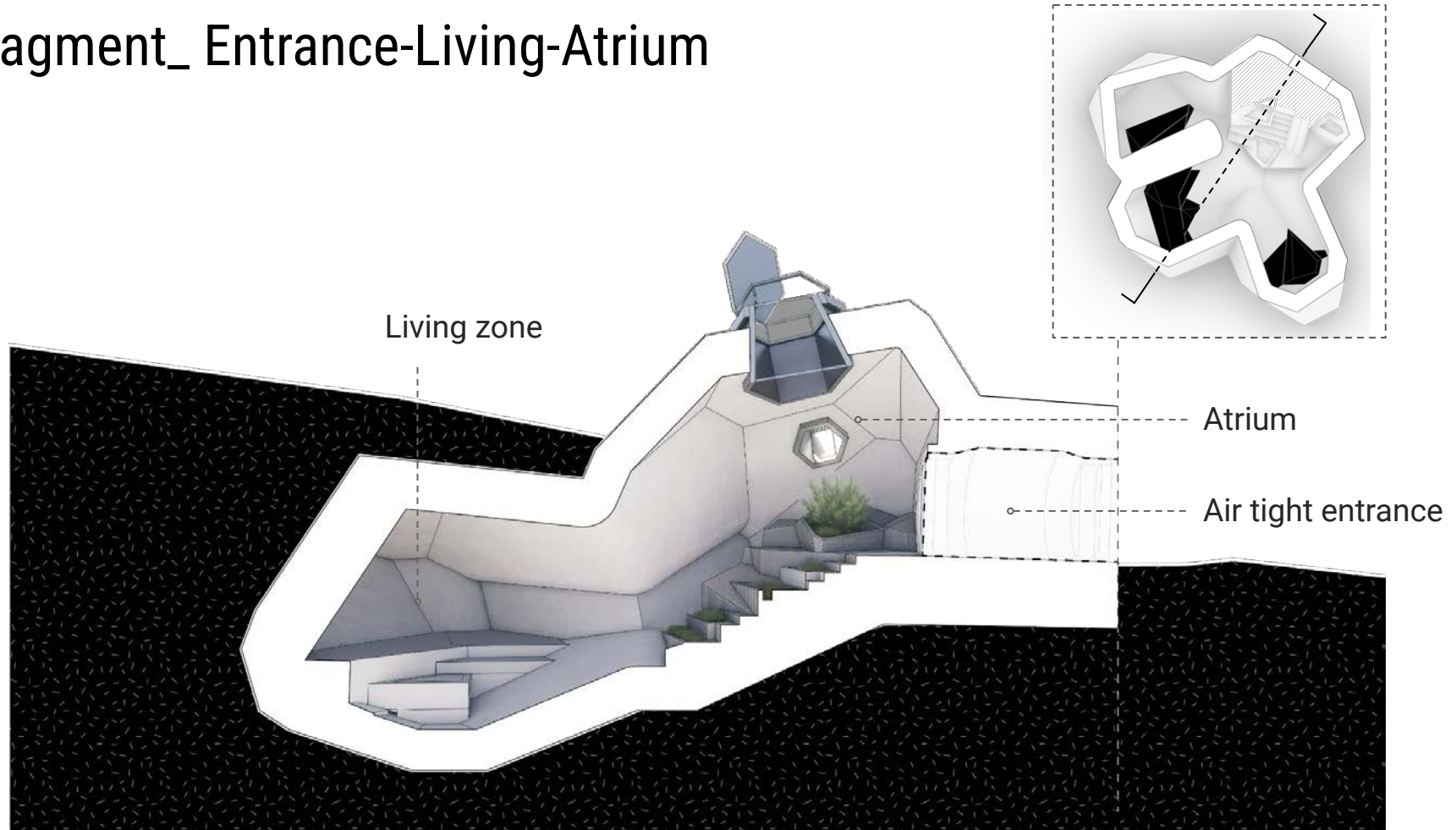

# Fragment\_ Form Finding

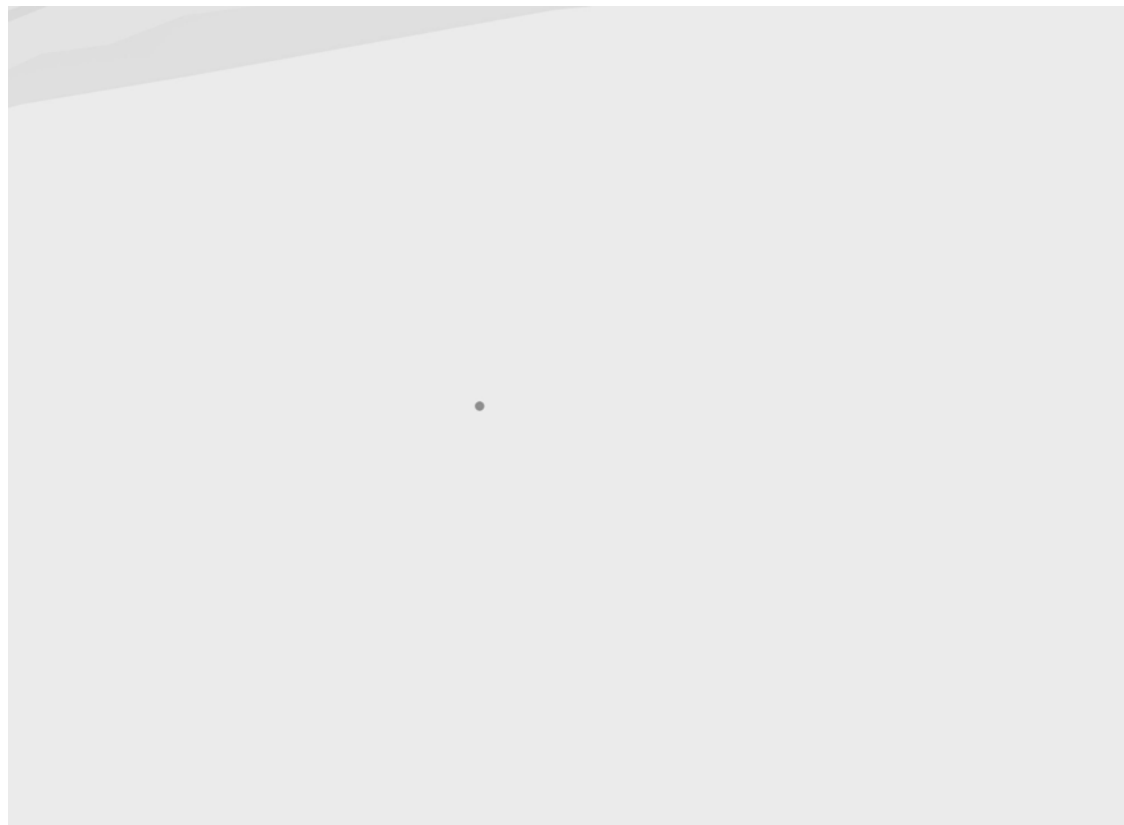

Central point selection  
for atrium



# Fragment\_ Form Finding

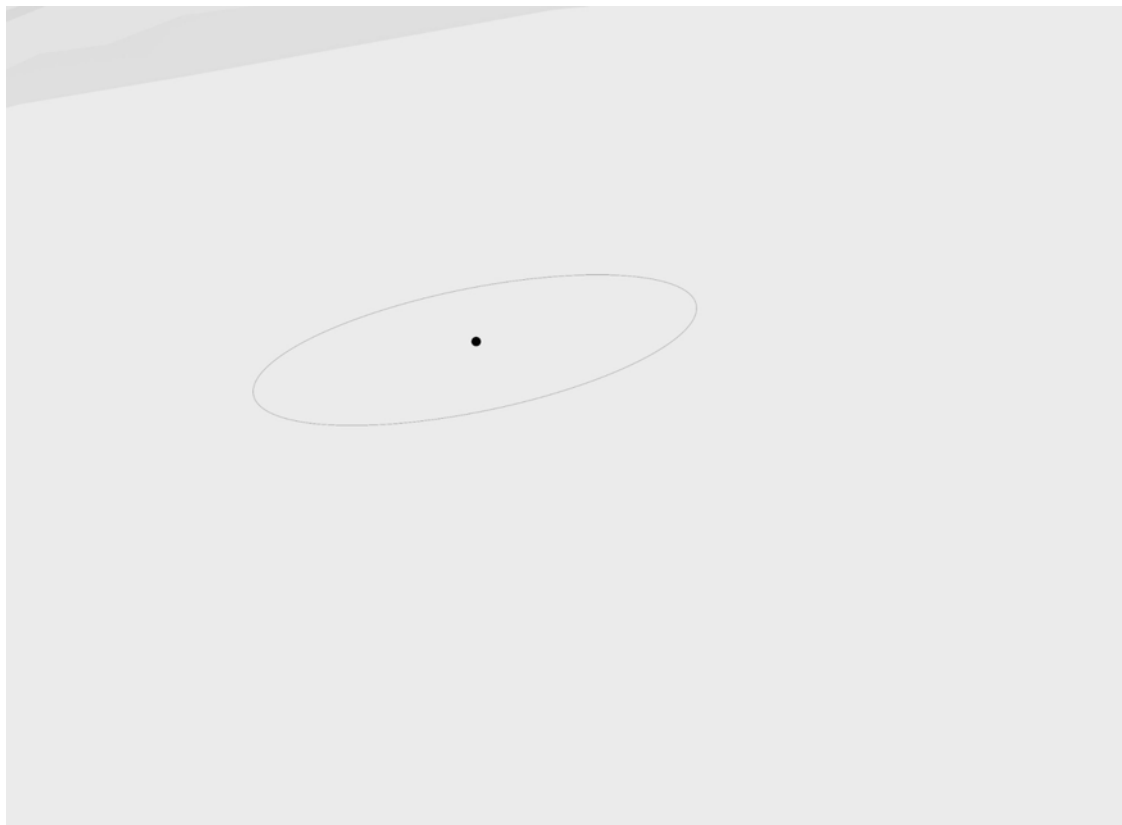

Circle generated from  
the atrium central point

# Fragment\_ Form Finding



Circle points selection  
for entrance and living  
units

# Fragment\_Form Finding

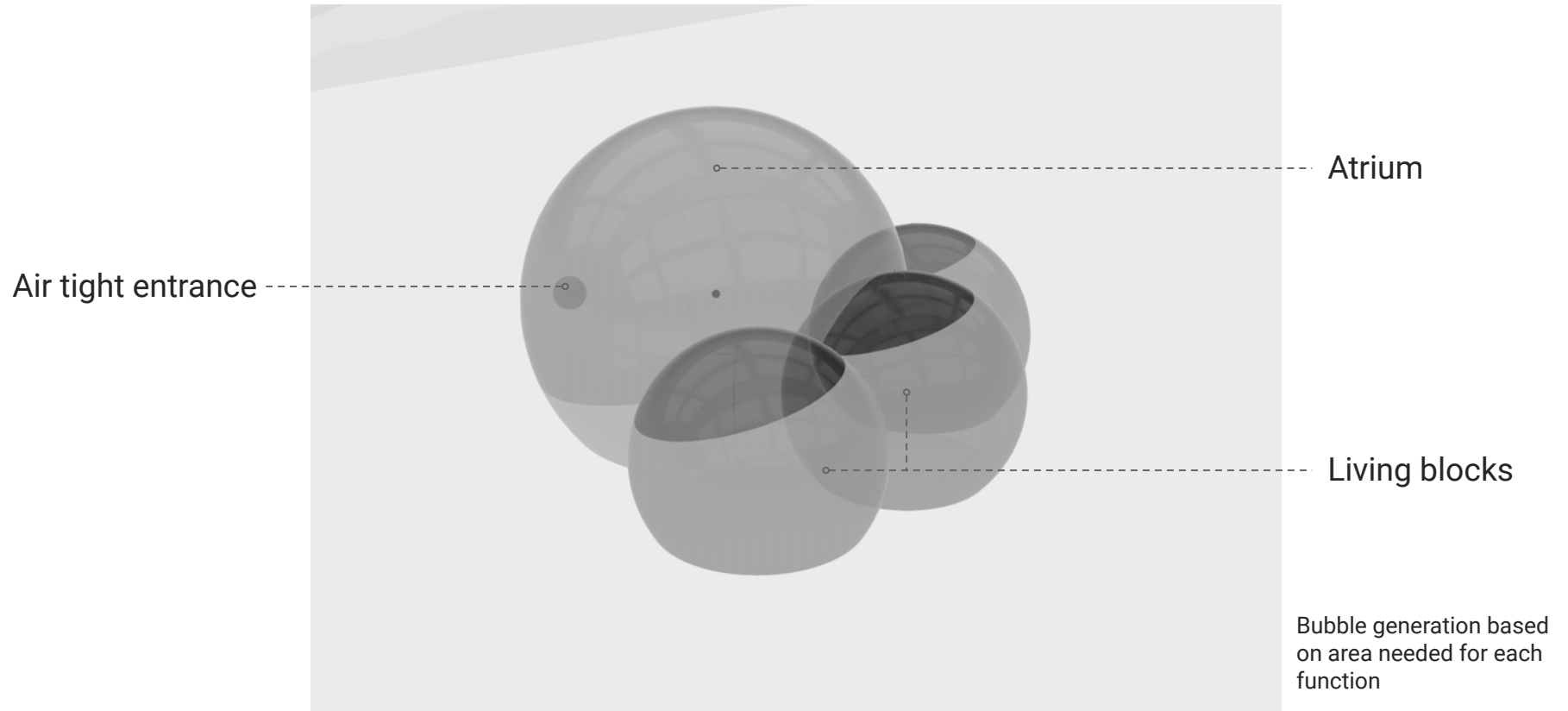

# Fragment\_ Form Finding

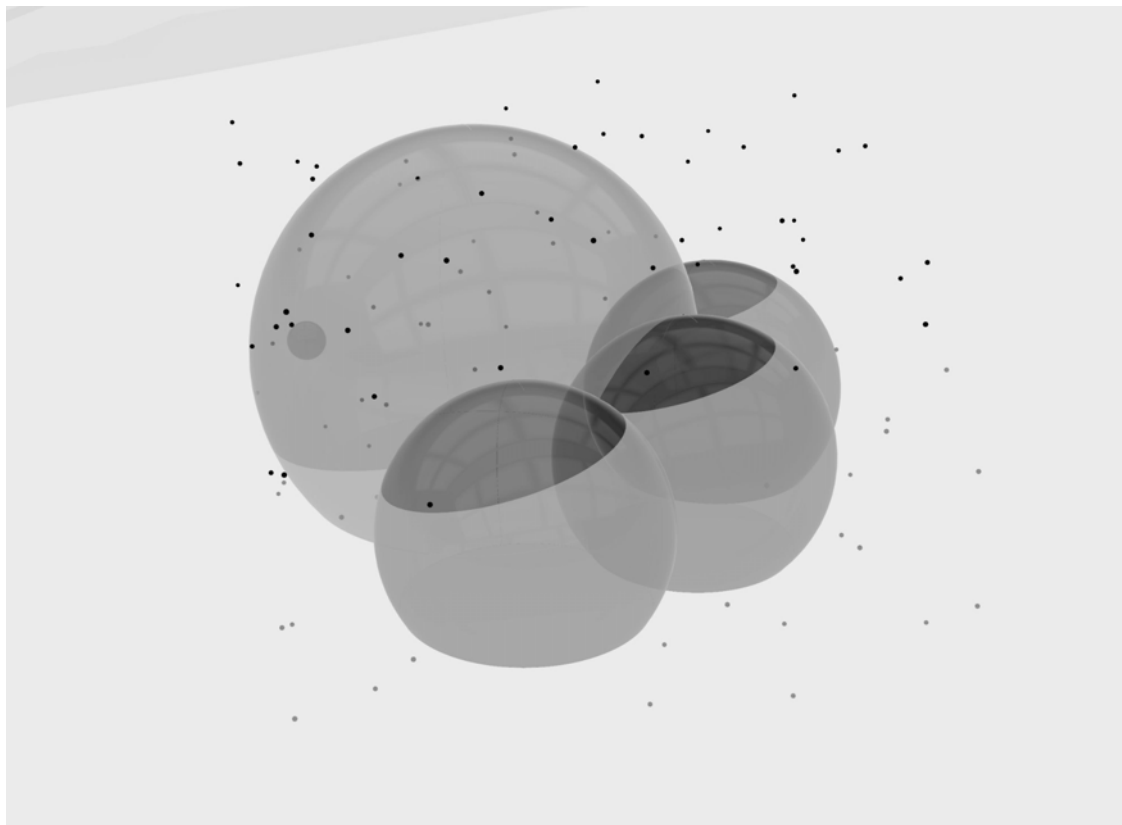

Generation of random  
point cloud

# Fragment\_Form Finding

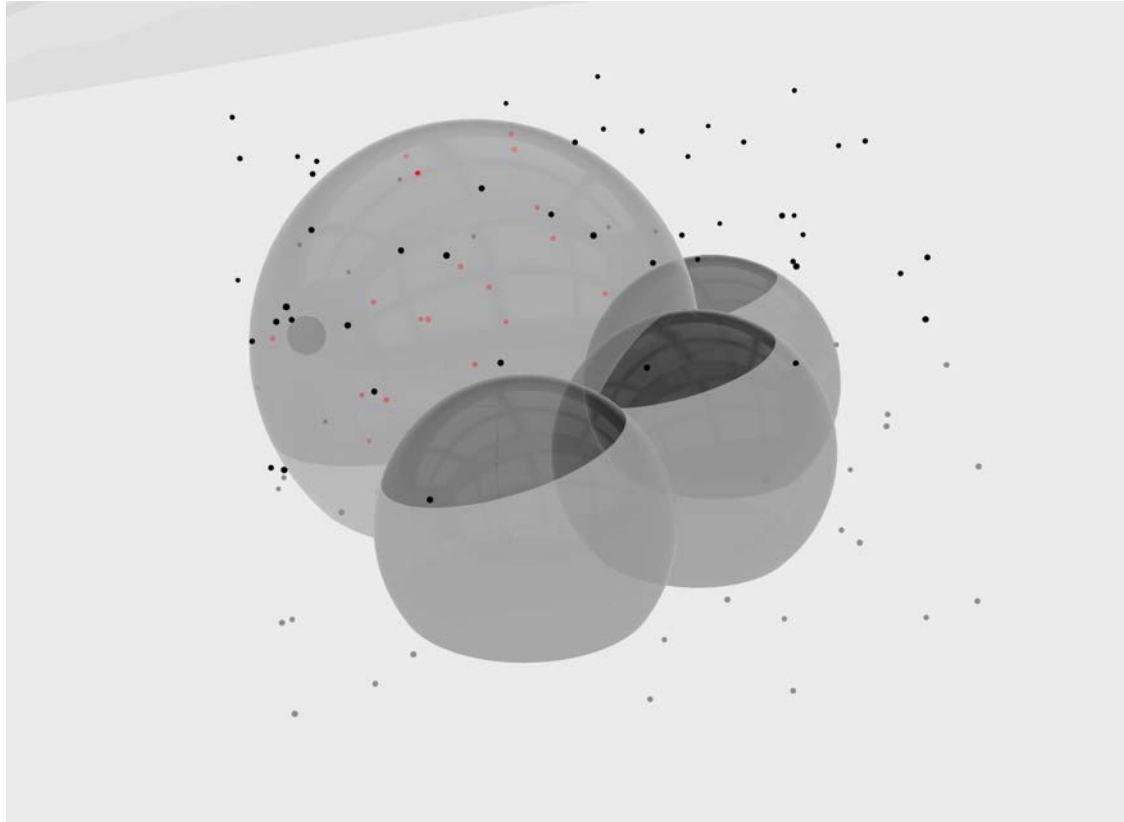

Dispatch of points inside  
and outside the bubbles

# Fragment\_ Form Finding

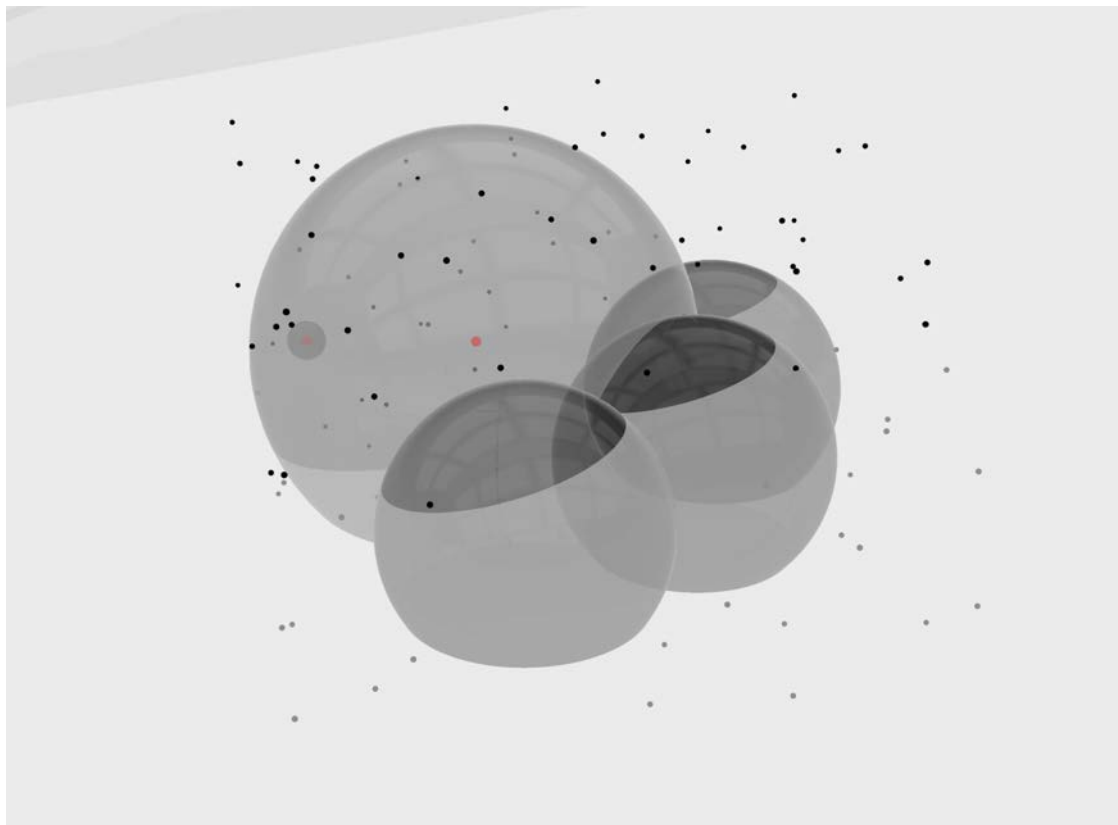

Replacement of points  
inside the bubbles to  
central points of the  
bubbles

# Fragment\_ Form Finding

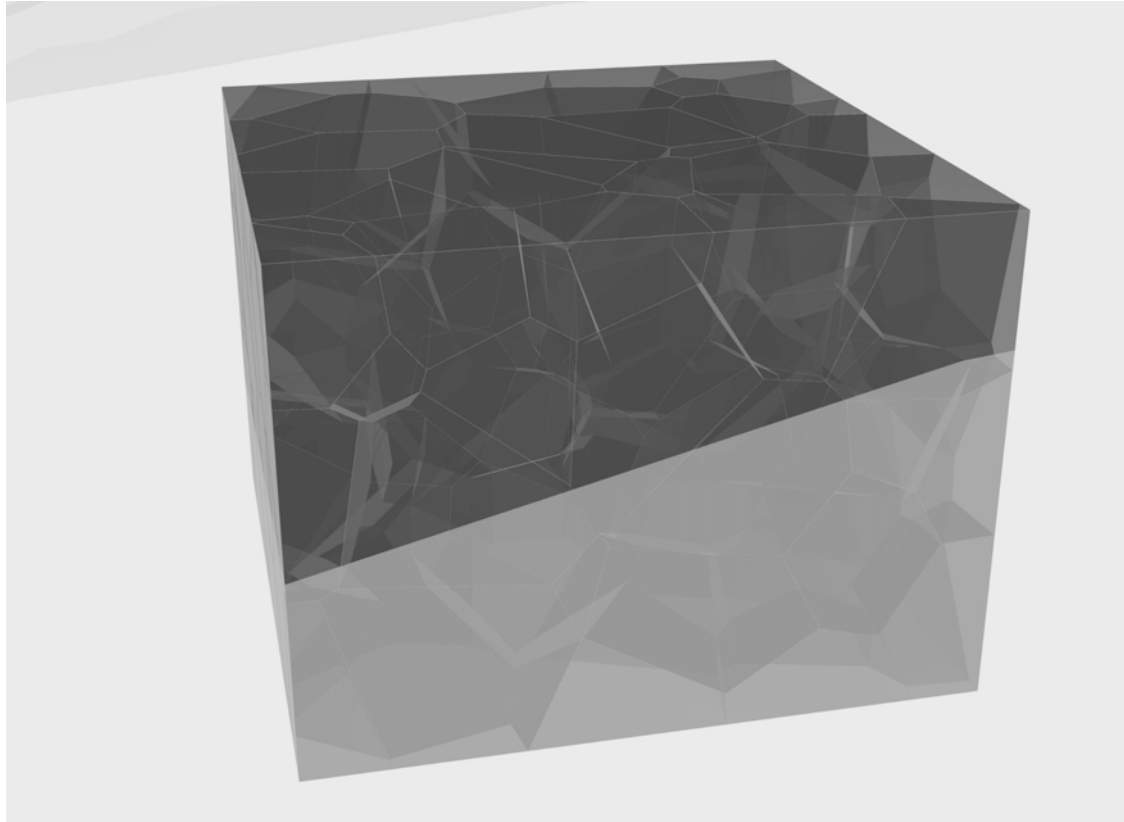

Generation of voronoi  
shape based on  
bounding box

# Fragment\_ Form Finding

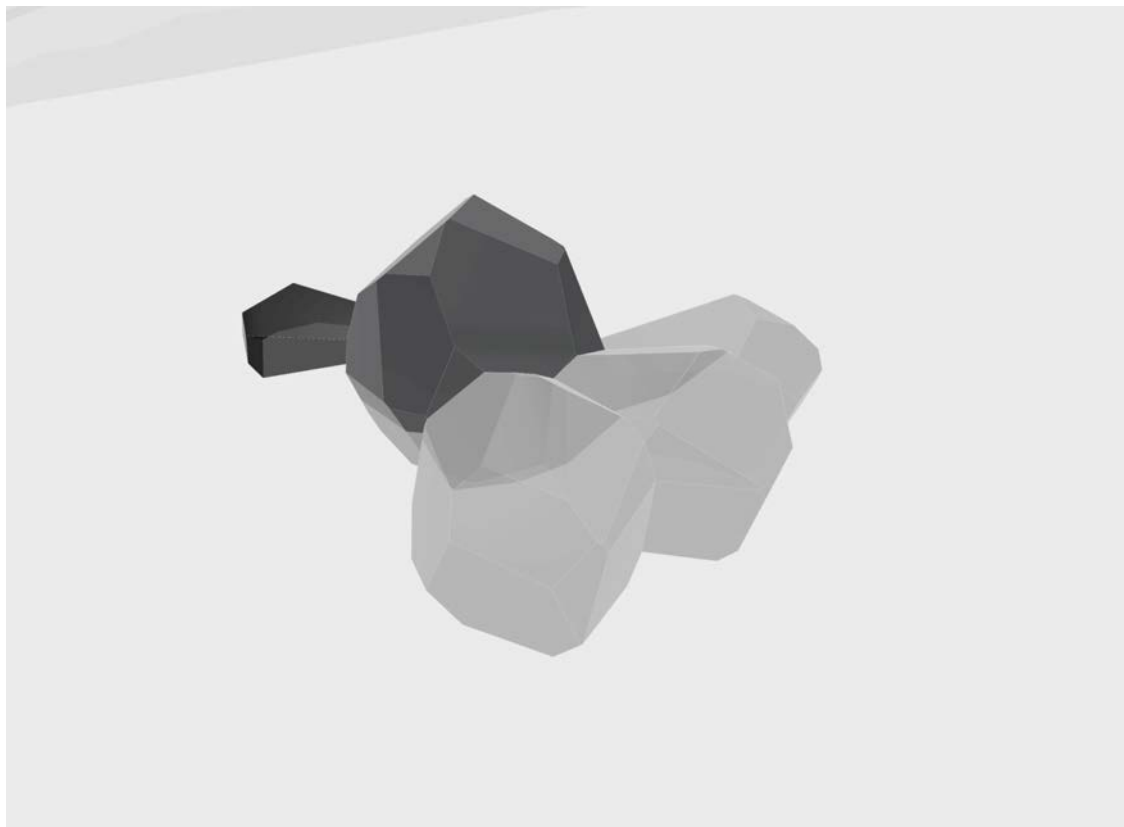

Corresponding voronoi  
shape of the bubble



Assembly Concept + Interlocking Fragment

# Fragment\_Entrance-Living-Atrium

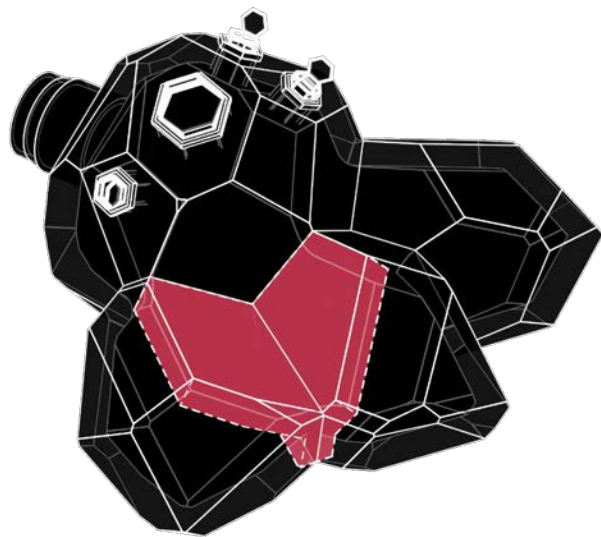

# Fragment

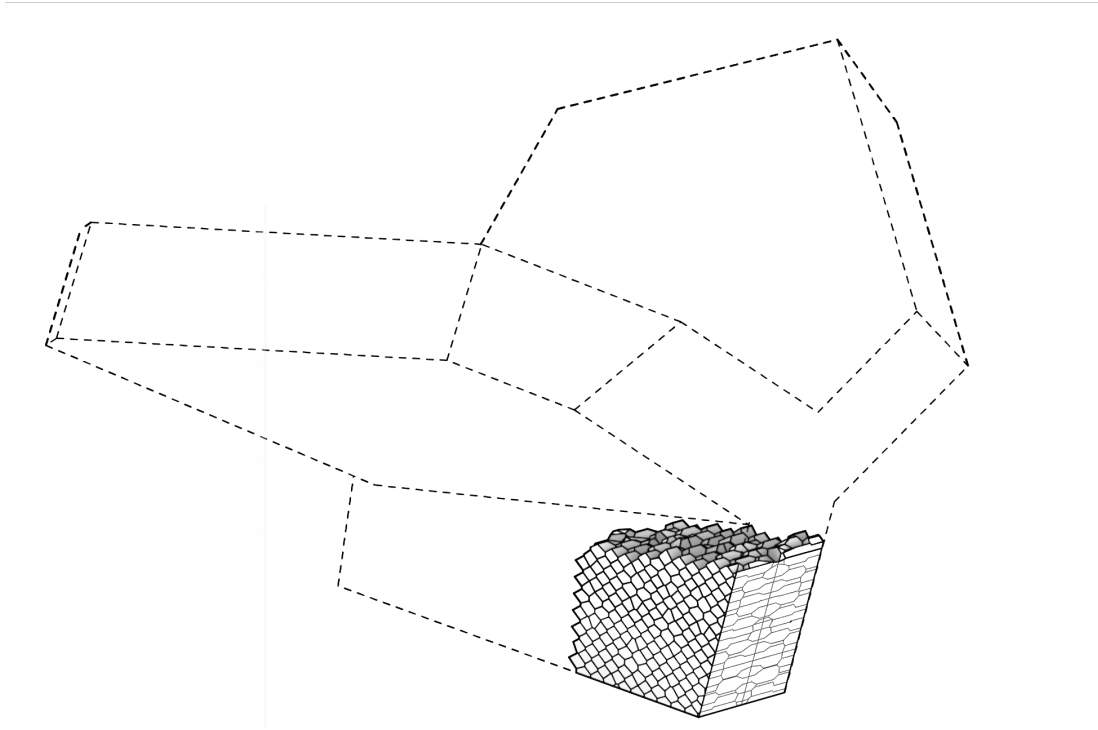

# Assembly\_ Interlocking concept\_ Scutoids

## Scutoid Brick

The Designing of Epithelial cell inspired-brick in Masonry shell System

Teng Teng<sup>1</sup>, Mian Jia<sup>2</sup>, Jenny Sabin<sup>1</sup>  
<sup>1,2,3</sup>Cornell University  
<sup>1</sup>ts37@cornell.edu <sup>2,3</sup>mj554jes557@cornell.edu

This paper focuses on the design of individual bricks in a masonry shell system that are inspired and informed by the reorganization of epithelial cells within tissues. Starting from a newly discovered shape called "Scutoid", we first investigated how epithelial cells within living animals are packed three dimensionally within tissues. We focused on the living mechanisms within these cells that facilitate tissue curvature in the creatures' organs, skin, and blood vessels. By utilizing this generative geometric approach, we created a series of parametric generators and modeling kits to represent this mechanism and process. We then explored the potential for adopting this mechanism into larger-scale settings. Meanwhile, we discovered that the deformation of individual epithelial cells during the bending process generates an intriguing triangular connection along the bending direction. We managed to translate this unique feature to the architectural scale as a joint system for connecting bricks in a masonry shell structure. Based on the above findings, we designed and fabricated a set of models for the masonry shell structure that are generated from scutoid bricks and this unique joint. The geometrical characteristics of scutoid bricks allows the packing of four bricks with just two joints. The work that we have generated thus far contributes to solving issues of shell design and fabrication from the perspective of individual units. The result of the shell structure model demonstrates that applying the epithelial cell inspired-block masonry system is a feasible approach for the construction of shell structures.

**Keywords:** Epithelial cell, Scutoid, Bio-inspired Design, Generative Design, Masonry shell

### INTRODUCTION & BACKGROUND

Due to the limitation of imaging technology at the nanoscale, a comprehensive visualized description of epithelial cells' three-dimensional appearance has been missing from the field until recently. Most

biological researchers understood the shape to be similar to columnar prisms or a frustum shape. In 2018, through the approach of mathematical modeling, A group of scientists from Universidad de Sevilla (Gomez-Gomez, Pedro, et al, 2018) unexpectedly

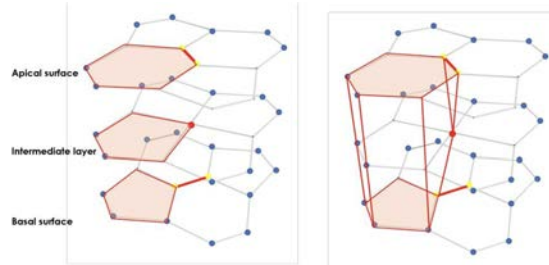
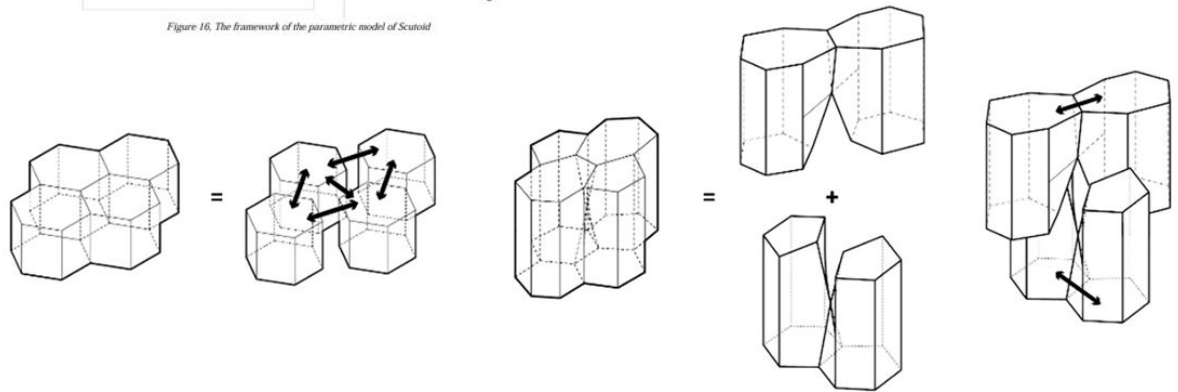

Figure 16. The framework of the parametric model of Scutoid



# Assembly\_ Interlocking concept\_ Scutoids



Computers & Graphics  
Volume 82, August 2019, Pages 73–83



Special Section on SAM 2019

## Delaunay Lofts: A biologically inspired approach for modeling space filling modular structures

Sri Ganesha Subramanian<sup>a</sup>, Mathew Eng<sup>b</sup>, Vinayak B. Krishnamurthy<sup>a</sup>, Ergun Akleman<sup>b</sup>

Show more

+ Add to Mendeley Share Cite

<https://doi.org/10.1016/j.cag.2019.05.021>

Get rights and content

### Highlights

- We develop a generalized approach for constructing 3D space-filling tilings, called Delaunay Lofts.
- Our approach interpolates any number of tiled layers whose dual tilings are Delaunay diagrams.
- We describe a method for the direct control of the topological change across the tiled layers in Delaunay Lofts.
- We describe an algorithm to practically construct Delaunay Lofts in real-time at arbitrary resolutions.
- We explore the design space of such tilings using wallpaper symmetries and conducted preliminary mechanical analysis.

## Delaunay Lofts: A Biologically Inspired Approach for Modeling Space Filling Modular Structures

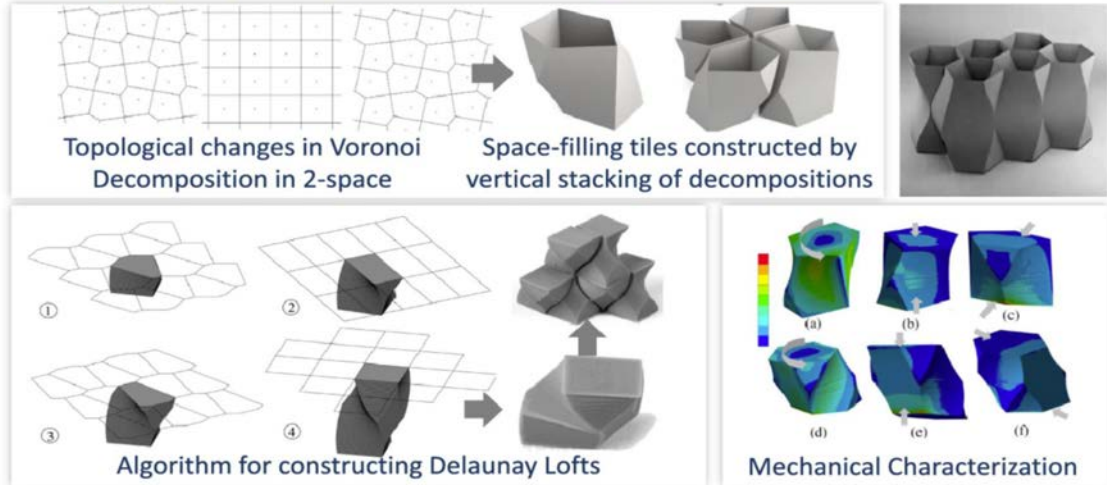

# Assembly\_ Generating interlocking voronoi

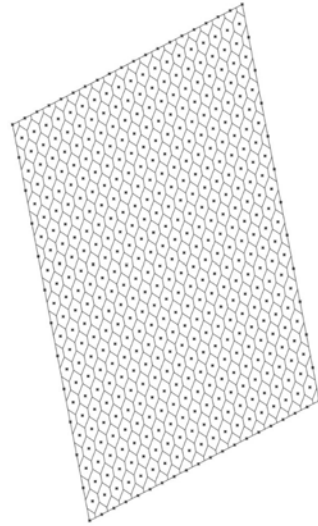

Uniform hexagonal cell generated of the surface

# Assembly\_ Generating interlocking voronoi

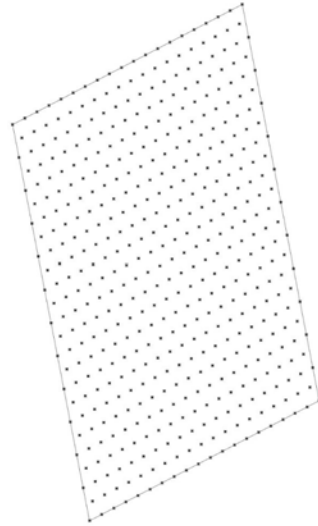

Uniform points grid generated from hexagonal cell

# Assembly\_ Generating interlocking voronoi

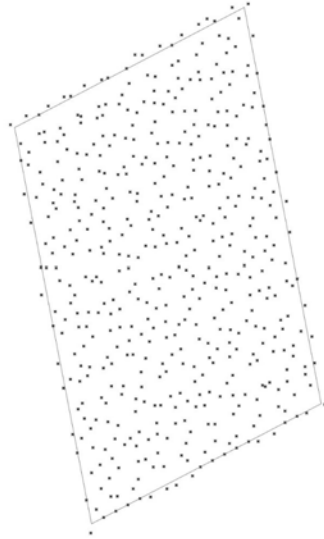

Attractive point to add complexity to the grid  
(attractive point might be based on structural optimization  
or other factors )



# Assembly\_ Generating interlocking voronoi

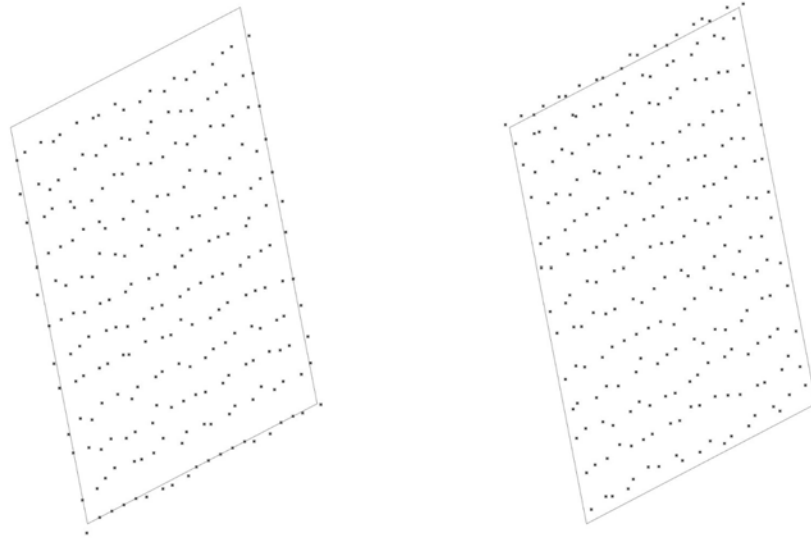

Dispatch the point cloud into 2 clusters

# Assembly\_ Generating interlocking voronoi

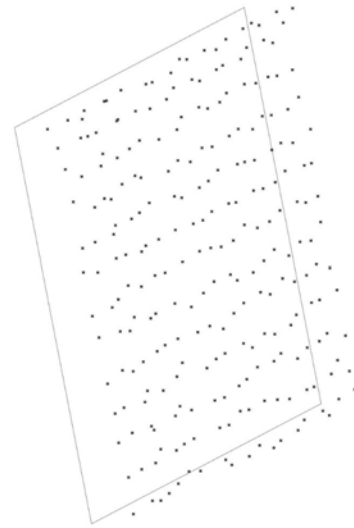
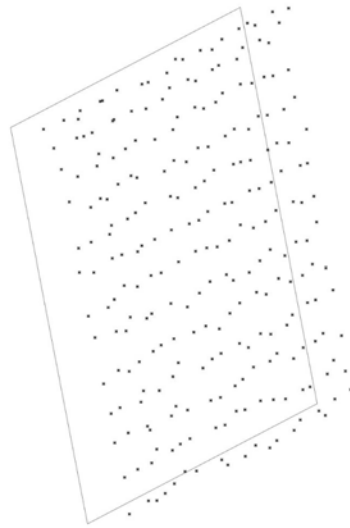
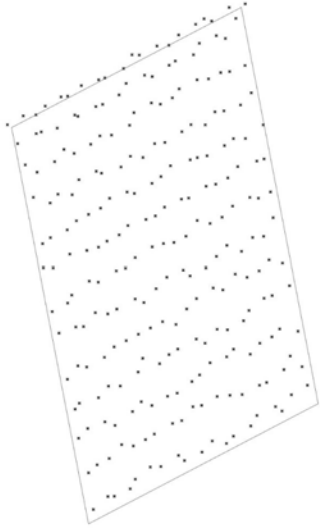

Movement of point in 3 layers

# Assembly\_ Generating interlocking voronoi

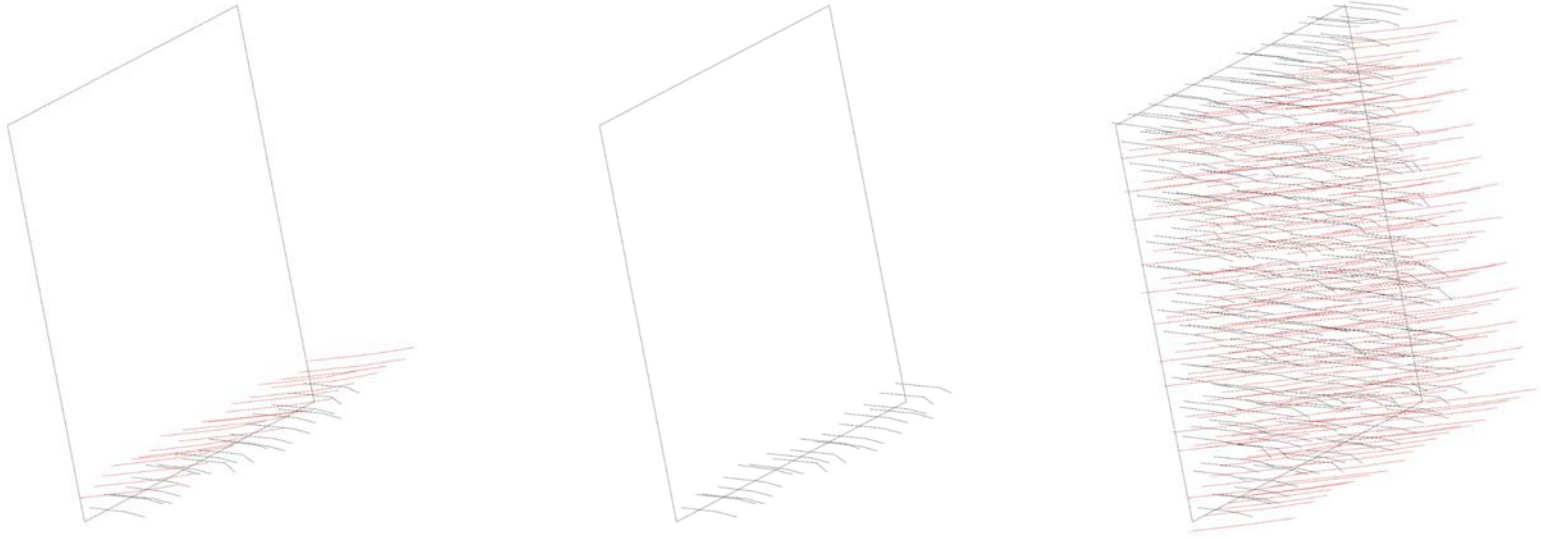

Crossing lines generated as baseline for interlocking voronoi shapes

# Assembly\_ Generating interlocking voronoi

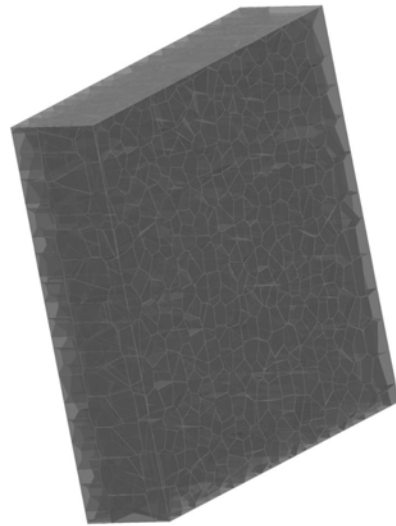

Voronoi shape generated based on points on cross line

# Assembly\_ Generating interlocking voronoi

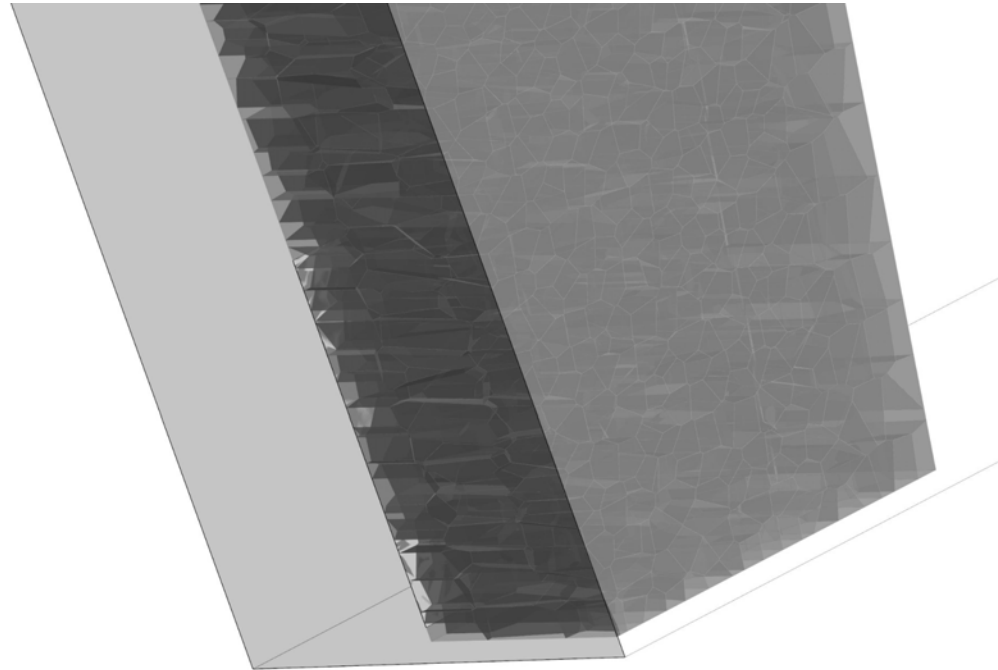

Scaled to the wall thickness

# Assembly\_ Interlocking component

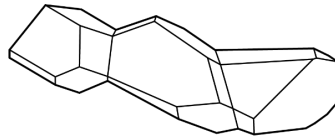

One component generated based on 3 points

# Assembly\_Fragment selection

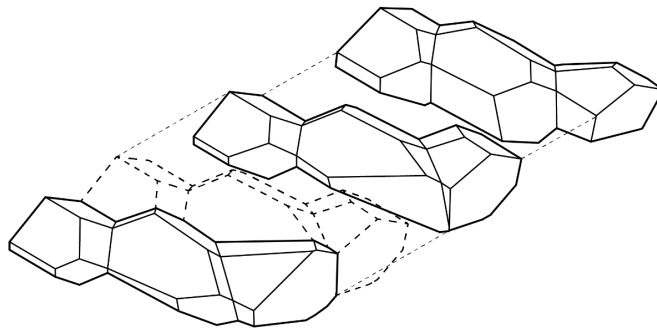

Interlocking horizontally

# Assembly\_Fragment selection

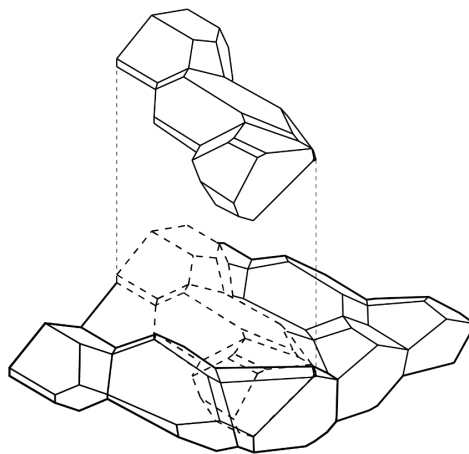

Interlocking vertically



# Assembly\_Fragment selection

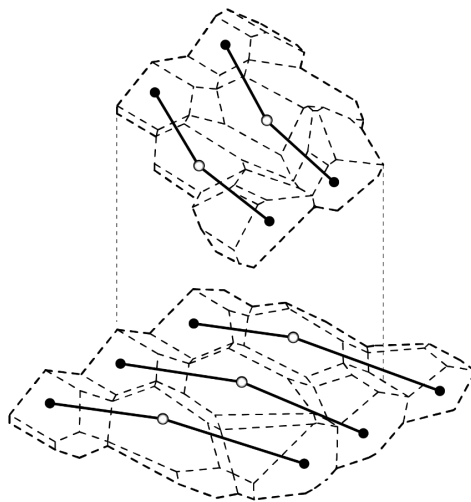

Interlocking vertically

# Assembly\_Fragment selection

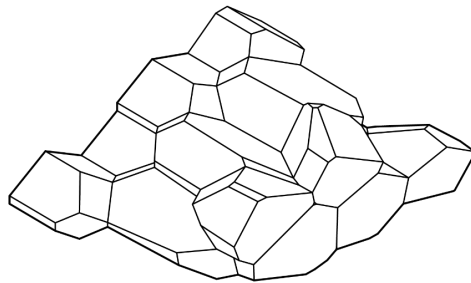

# Assembly processes animation

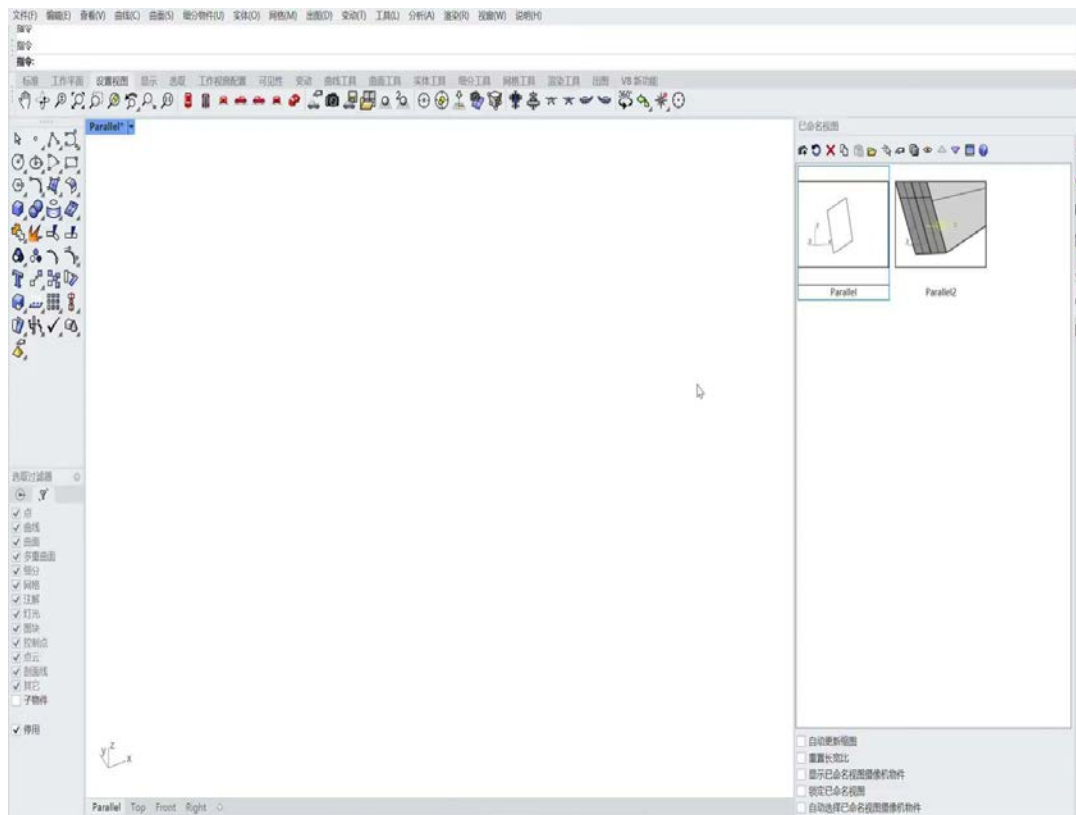

# Prototyping: Milling Process

# Robotic Milling\_Processes

For 1:1 scale prototype testing,  
Robotic milling of EPS  
foam block is used for  
the fabrication method  
and HRI

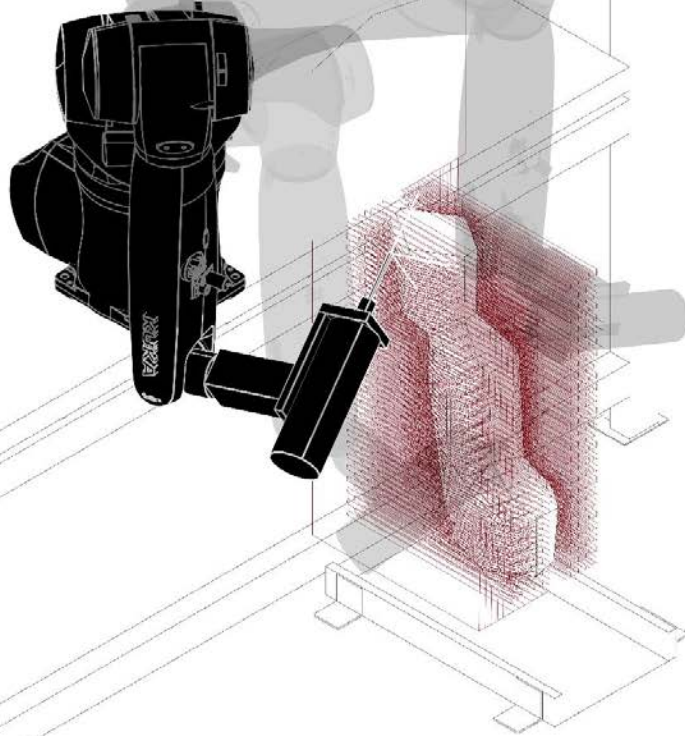

## Processes

1. Isolate naked faces
1. Create tool paths for the faces
2. Texturized faces and holes

# Robotic Milling\_Simulation

Steps:

1. Material removal side 1+ 2
2. High Res milling for component angles
3. High res milling for component holes

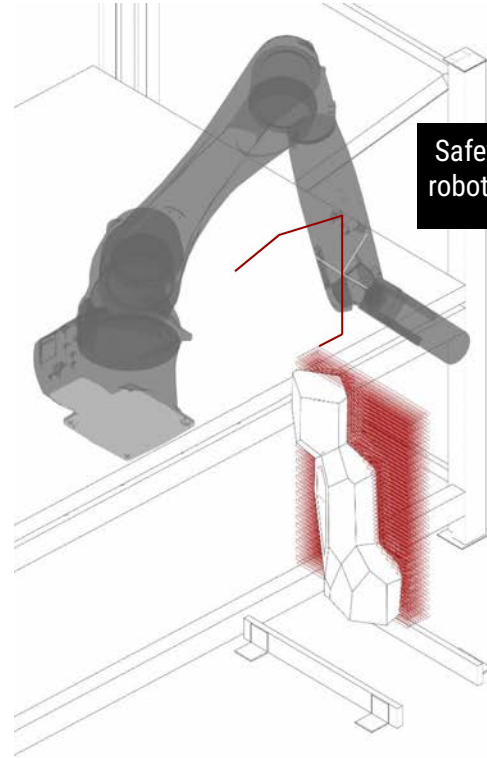
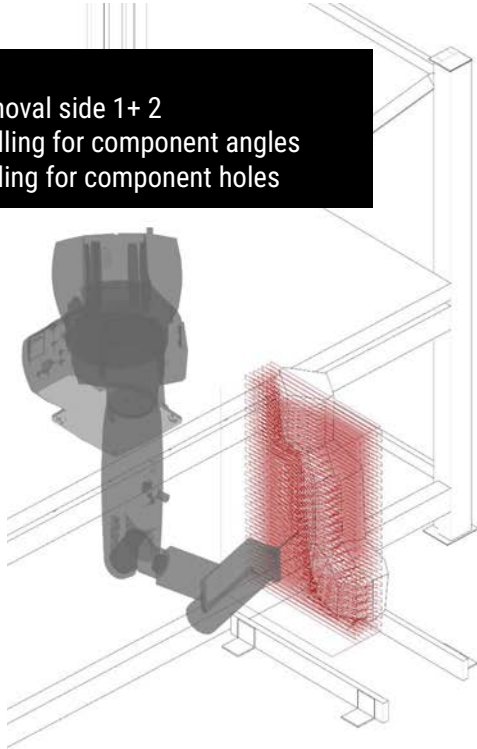

Safety points to guide movement of robotic arm to avoid collisions

# Robotic Milling\_Prototype



# Robotic Milling\_ Grabbing Holes





# Human-Robot Interaction

# Construction processes

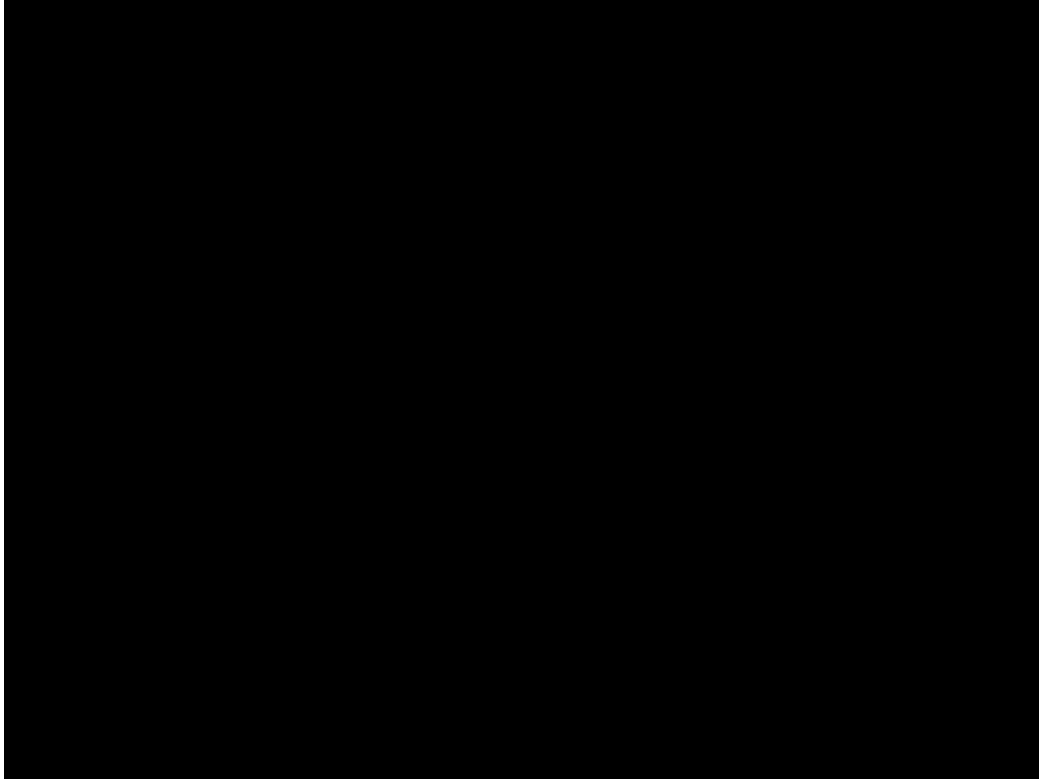

# Construction processes

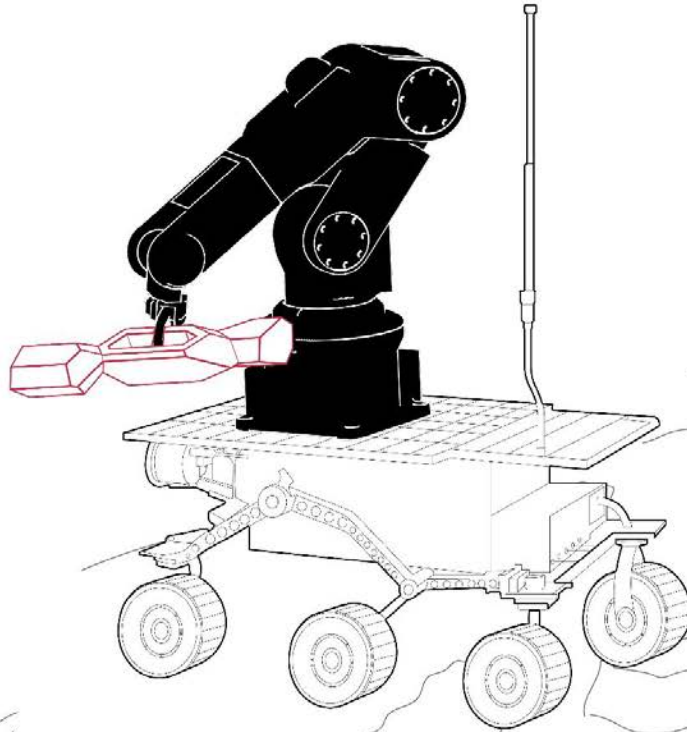

Robotic arm for assembly can be placed on a rover with wheels to move components around construction

# Robotic Assembly

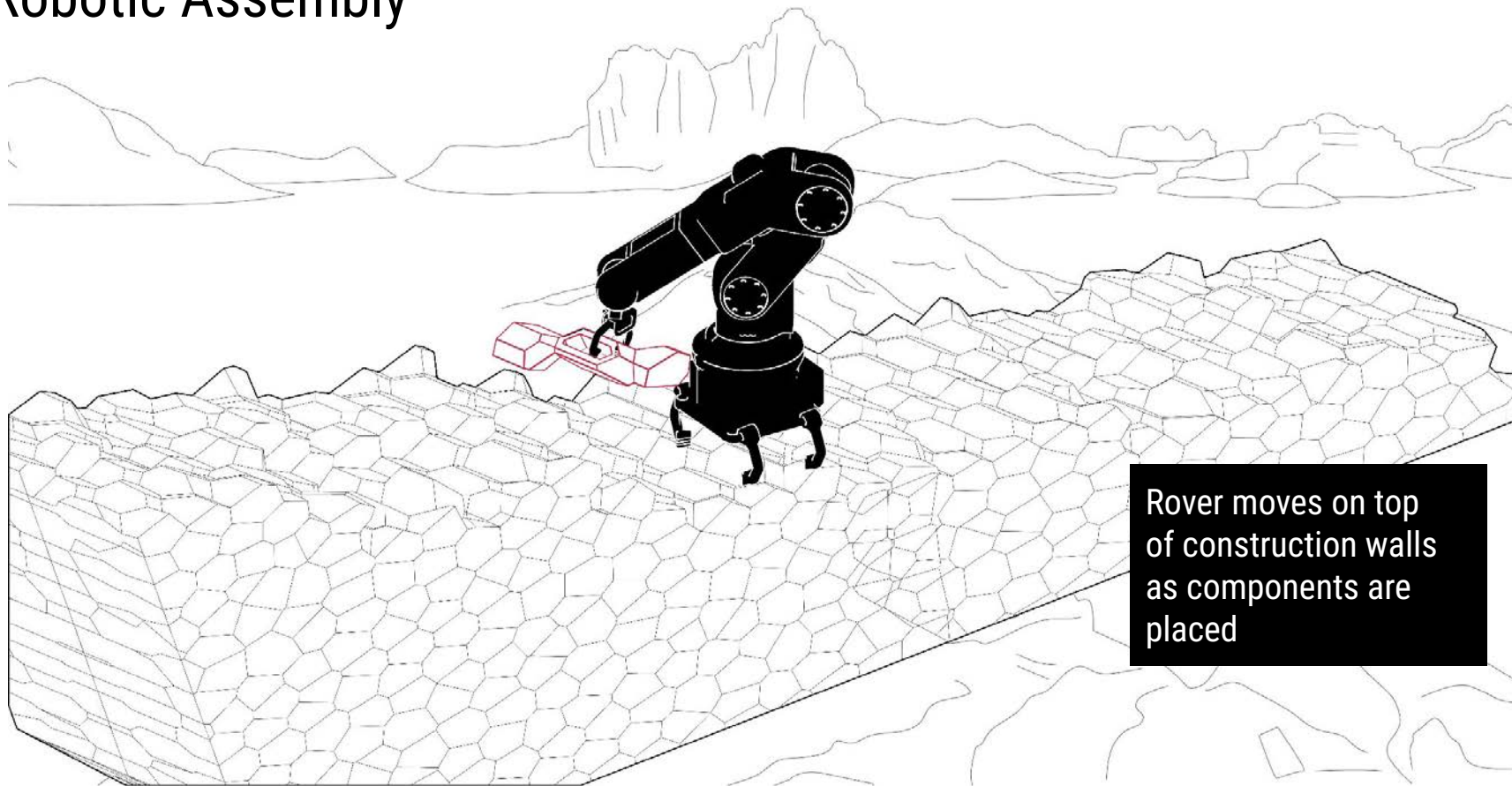

Rover moves on top of construction walls as components are placed

# Robotic Assembly

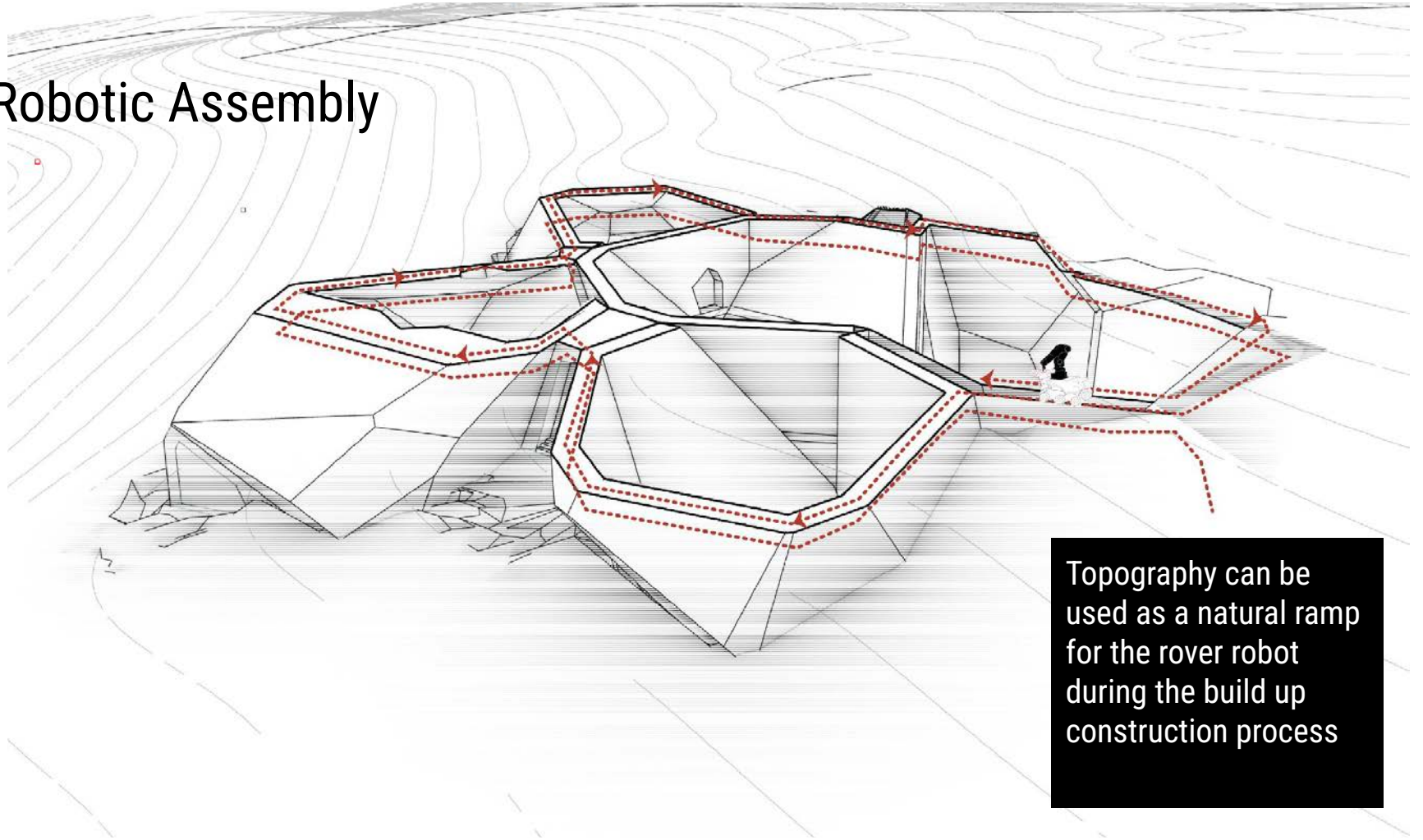

Topography can be used as a natural ramp for the rover robot during the build up construction process

Future Expansion



# Expansion Following Voronoi Language

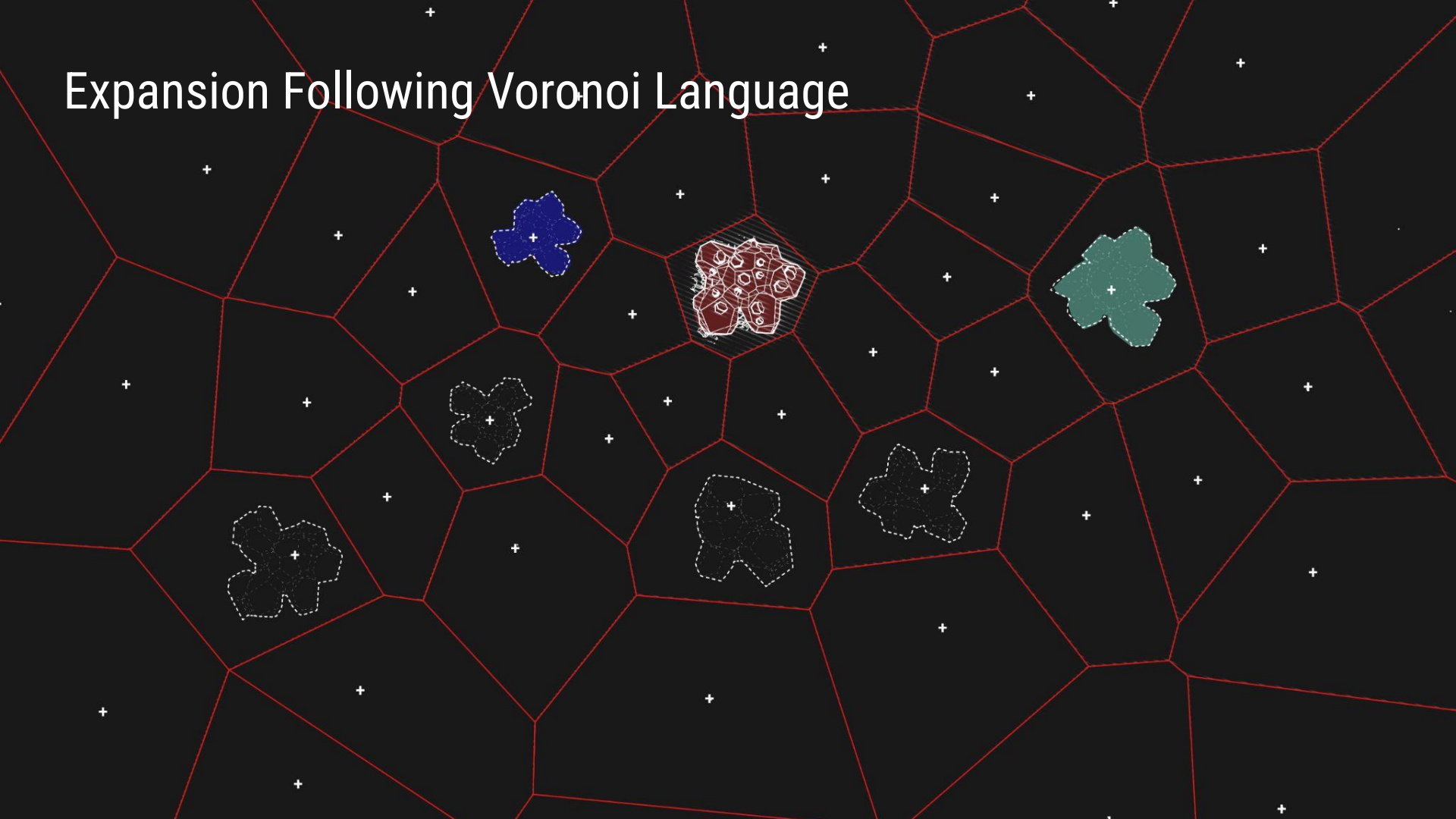



Animation

Animation